

# EQUINOX

600 | 800

## Instruction Manual



SHOP DETECTORS  
TEL : +1 206-401-9788  
WEB : <https://shopdetectors.com/>  
EMAIL : [contact@shopdetectors.com](mailto:contact@shopdetectors.com)

Multi-IQ

5F<sub>x8</sub>

3F<sub>x3</sub>

Wi-Stream

Bluetooth®

  
MINELAB

# Welcome

Congratulations on purchasing your EQUINOX metal detector.

Metal detecting is a fascinating and rewarding activity enjoyed by people all over the world. By getting to know your EQUINOX detector you can become one of the many who find gold nuggets, coins and treasure on a regular basis.

The EQUINOX is a high-performance detector incorporating Minelab's new Multi-IQ technology. With the assistance of this Instruction Manual, and the accompanying Getting Started Guide, you will quickly learn how to set up your detector for the best results.

Minelab wishes you every success on your detecting adventures.

The latest product instruction manuals and detector software updates are available at:

[→ www.minelab.com](http://www.minelab.com)

We also encourage you to visit our other online resources regularly. They are frequently updated and are a continually evolving source for product information.

[f @MinelabMetalDetectors](#)

[Treasure Talk Blog](#)

[/MinelabDetecting](#)

[Success Stories](#)

## Metal Detecting Code of Ethics

- Respect the rights and property of others.
- Observe all laws, whether national, state or local.
- Always obtain permission before searching sites.
- Never destroy historical or archaeological treasures.
- Leave the land and vegetation as it was.
- Always fill in your holes after digging.

*"At heavily hunted beaches when you need to cover ground quickly after a busy beach day, the EQUINOX's amazing recovery speed helps you to stay one step ahead of the beach hunting competition."*

– Gary Drayton, USA



*"EQUINOX is the most exciting detector I have used in a long time! It just keeps surprising me with what I'm finding in heavily detected parks."*

– Mark Williams, Australia



 An asterisk appears throughout the manual, indicating features only included with the EQUINOX 800 model.

# Contents

---

## Assembly & Getting Started

<b>Carton Contents</b>	<b>5</b>
<b>Assembly</b>	<b>6</b>
<b>Assembled Detector</b>	<b>7</b>
<b>Detector Battery</b>	<b>8</b>
Charging the Battery	8
Battery Status Indicator	8
Battery Maintenance	8
Operating With a Power Bank	8
<b>Control Panel</b>	<b>9</b>
<b>LCD Icons</b>	<b>10</b>
<b>Quick Start</b>	<b>11</b>
<b>Global and Local Settings</b>	<b>12</b>
Reset a Search Profile	12
Factory Reset the Detector	12

---

## Detecting Basics

<b>How Detectors Work</b>	<b>14</b>
<b>Key Detecting Concepts</b>	<b>15</b>
<b>Detecting Technique</b>	<b>16</b>
Holding the Detector	16
Adjusting the Length of the Shafts	16
Adjusting the Angle of the Coil	16
Sweeping the Coil	16
Targets	16
<b>Detector Sounds</b>	<b>17</b>
<b>Simple Detecting Exercise</b>	<b>18</b>
<b>Pinpointing Technique</b>	<b>19</b>
Coil Configuration and Pinpointing	19
Pinpointing a Target Manually	19
<b>Target Recovery</b>	<b>20</b>
Digging Tools	20
Recovering a Target	20

---

## Detect Modes

<b>Detect Modes</b>	<b>22</b>
Detect Mode Navigation	22
Adjusting Search Profiles	22
Choosing the Right Detect Mode	22
<b>Park</b>	<b>23</b>
<b>Field</b>	<b>24</b>
<b>Beach</b>	<b>25</b>
<b>Gold*</b>	<b>26</b>

---

## Detect Screen Functions

<b>Frequency</b>	<b>28</b>
Changing the Frequency	28
Single Frequency Operation	28
Frequencies and Detect Modes	28
Multi-IQ Technology	29
Single Frequency Ranges	29
<b>Target ID &amp; Discrimination</b>	<b>30</b>
Target ID	30
Discrimination Scale	30
Typical Target Examples	31
Target ID Accuracy	31
<b>Backlight</b>	<b>32</b>
Turning the Backlight On	32
Adjusting the Backlight Brightness	32
<b>User Profile*</b>	<b>33</b>
Save a User Profile	33
Activating the User Profile	33
<b>Sensitivity</b>	<b>34</b>
Sensitivity Indicator	34
Adjusting Sensitivity	34
Recommended Sensitivity Settings	34
<b>Depth Gauge</b>	<b>35</b>
<b>Pinpoint</b>	<b>36</b>
Pinpoint Visualisation	36
Pinpointing a Target	36

---

<b>Settings Menu</b>	<b>38</b>
Settings	38
Advanced Settings	38
Accessing Advanced Settings	38
Settings Menu Navigation	38
<b>Noise Cancel</b>	<b>39</b>
Auto Noise Cancel	39
Manual Noise Cancel*	39
<b>Ground Balance</b>	<b>40</b>
Manual Ground Balance	40
Auto Ground Balance	40
Tracking Ground Balance	41
<b>Volume Adjust</b>	<b>42</b>
Adjusting the Volume	42
<b>Tone Volume (Advanced Setting)</b>	<b>43</b>
Adjusting Tone Volume	43
<b>Threshold Level</b>	<b>44</b>
Adjusting the Threshold Level	44
Gold Threshold	44
Threshold Blanking	44
Park, Field, and Beach Threshold	44
<b>Threshold Pitch* (Advanced Setting)</b>	<b>45</b>

Adjusting the Threshold Pitch	45
<b>Target Tone</b>	<b>46</b>
Selecting the Number of Target Tones	46
<b>Tone Pitch (Advanced Setting)</b>	<b>47</b>
Adjusting Tone Pitch: 1, 2, or 5 Tones	47
Adjusting Tone Pitch: 50 Tones	48
<b>Accept/Reject</b>	<b>49</b>
Creating a Discrimination Pattern	49
All Metal	49
Accepting/Rejecting Detected Targets	49
<b>Tone Break (Advanced Setting)</b>	<b>50</b>
Adjusting Tone Break	50
<b>Recovery Speed</b>	<b>51</b>
Swing Rate	51
Adjusting Recovery Speed	51
<b>Iron Bias (Advanced Setting)</b>	<b>52</b>
Adjusting Iron Bias	52

---

## Detector Audio

<b>Audio Options</b>	<b>54</b>
<b>Wireless Audio Latency</b>	<b>54</b>
<b>WM 08 Wireless Audio Module</b>	<b>55</b>
Pairing the WM 08	55
Pairing Additional WM 08 Modules	55
Charging the WM 08	55
<b>ML 80 Wireless Headphones</b>	<b>56</b>
Pairing Wireless Headphones	56
Adjusting ML 80 Volume	56
ML 80 Factory Reset	57
Charging ML 80 Headphones	57
ML 80 Auxiliary Cable	57
Smart Phone Call Functions	57
Smart Phone Music Functions	57
<b>Wired Headphones</b>	<b>58</b>
Connecting Wired Headphones	58
Adaptor Cable	58
Connecting Waterproof Headphones	58
Headphone Socket Submersion	58

---

## Care & Safety

<b>EQUINOX Accessories</b>	<b>60</b>
<b>Maintenance &amp; Safety</b>	<b>61</b>
<b>Factory Presets</b>	<b>62</b>
<b>Troubleshooting</b>	<b>63</b>
<b>Error Codes</b>	<b>64</b>
<b>Technical Specifications</b>	<b>65</b>
Software Updates	66



## Assembly & Getting Started

This section will show you how to assemble your EQUINOX Series detector, charge the battery, and will introduce you to the control panel.

## Carton Contents

EQUINOX Series detectors come with everything you need to get started detecting. The EQUINOX 800 comes with additional accessories for even greater versatility.

For a list of the main accessories that are compatible with your detector, read 'EQUINOX Accessories' on page 60.

→ Go online to see the full range at [www.minelab.com/equinox-accessories](http://www.minelab.com/equinox-accessories).



USB charging cable with magnetic connector



Multi-language screen protector pack



Getting Started Guide (x2)  
(English and Russian)



Carton contents reference  
(English and Russian)

### Included with EQUINOX 600



3.5 mm (1/8-inch) wired headphones

### Included with EQUINOX 800



WM 08 wireless audio module

USB charging cable with magnetic connector



Hard shell case

ML 80 wireless headphones

ML 80 instruction sheet

Auxiliary cable  
3.5 mm (1/8-inch)

USB charging cable



Items and specifications may vary slightly from those shown and may be subject to change.

# Assembly

Follow these easy steps to assemble your EQUINOX Series detector.

## Attach coil to lower shaft

1. Insert the two yoke washers into the holes on either side of the yoke.
2. Slide the yoke into the yoke bracket on top of the coil.
- ⚠ Ensure that the spring loaded pin in the lower shaft is underneath.
3. Insert the yoke bolt through the yoke and the yoke bracket.
4. Fasten with the yoke nut - Do not over-tighten.

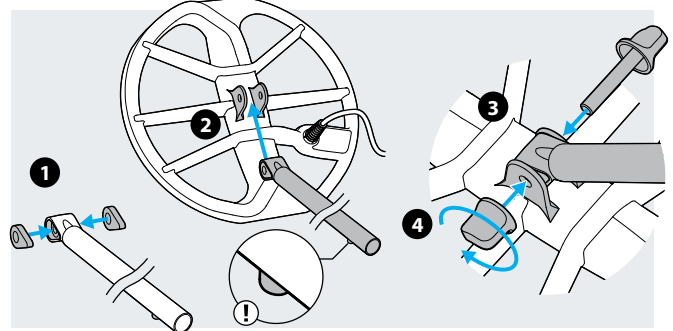

## Assemble shafts

1. Loosen the twistlocks by rotating them counter-clockwise.
2. Press the spring loaded pin in the lower shaft and slide it into the middle shaft until the pin reaches the adjustment holes. The pin will click into place.
3. Attach the middle shaft to the upper shaft in the same way.
4. Lock the position of the shafts by rotating twistlocks clockwise.

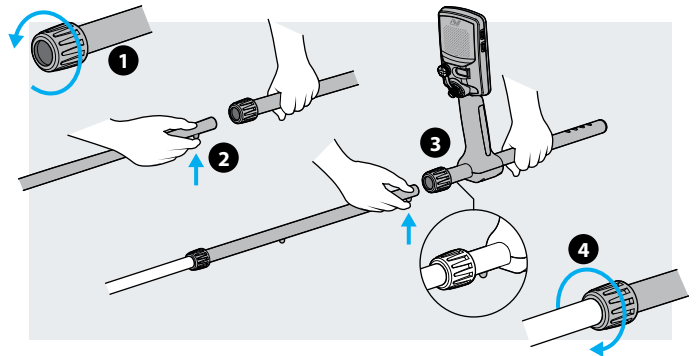

## Attach armrest

1. Place the armrest onto the top of the upper shaft. Position the armrest just below your elbow, then align the central hole in the armrest with the nearest hole in the shaft.
2. Insert the screw through the stand, upper shaft and armrest. Tighten the screw carefully.
3. With the velcro side facing upwards, thread the armrest strap through both slots in the armrest. Ensure the end of the strap will be fastened outwards from your arm.

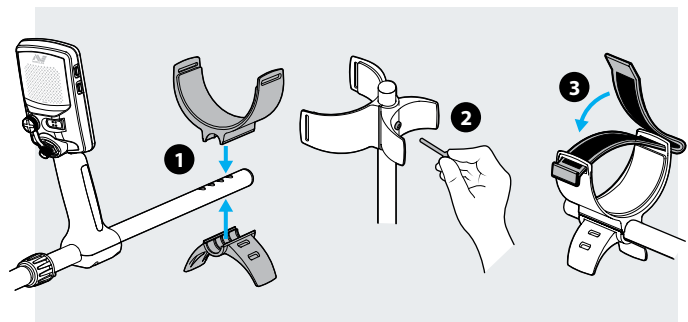

## Connect coil

1. Wrap the coil cable around the lower and middle shaft enough times to take up the slack, but so the coil can still tilt without restriction.
2. Use the velcro tabs provided to secure the coil cable against the shaft.
3. Align the coil connector and plug into the socket in the back of the control unit, tightening the retaining ring.

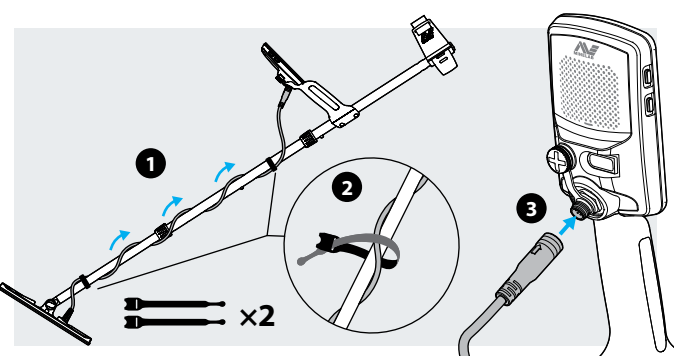

# Assembled Detector

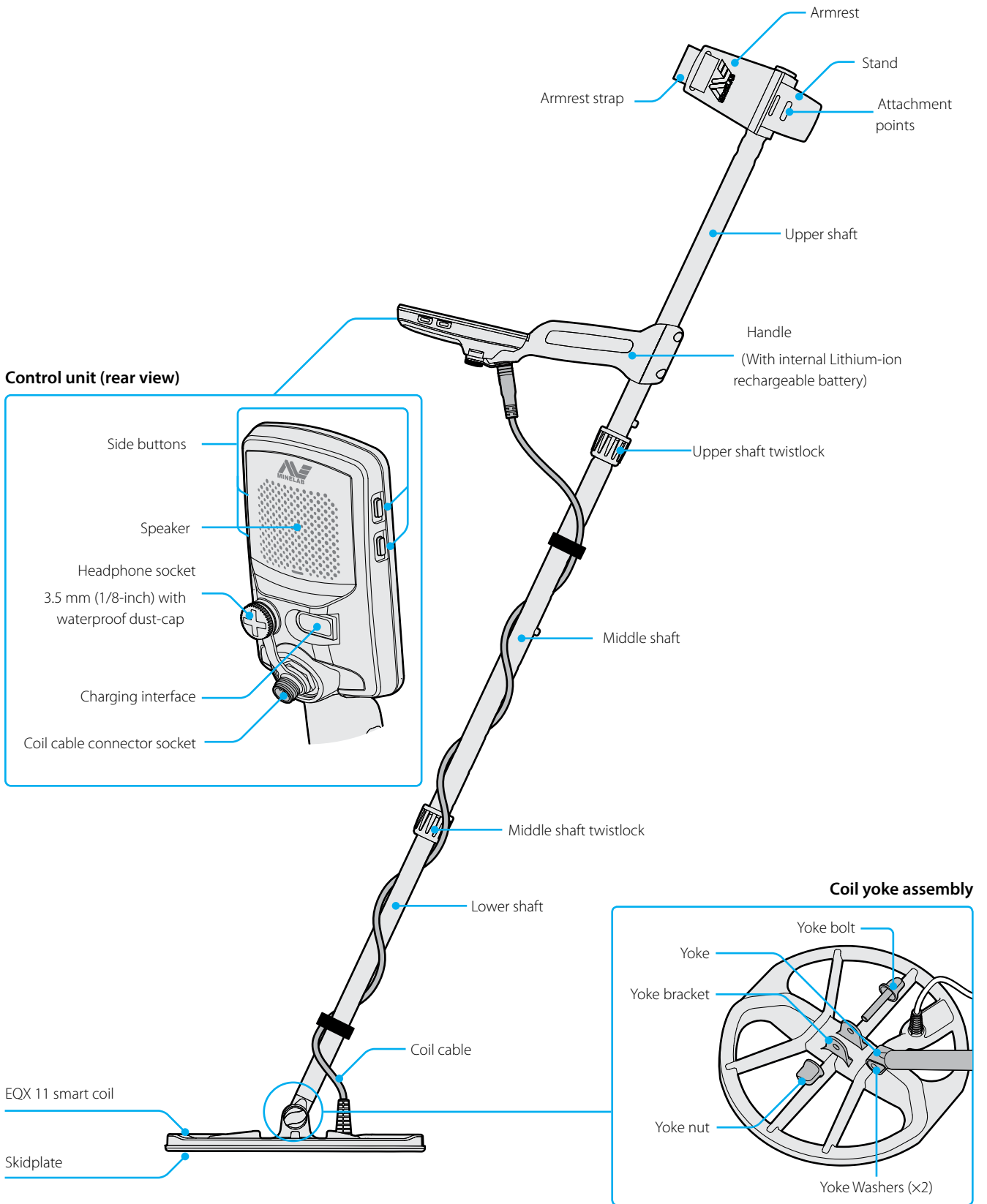

# Detector Battery

The EQUINOX detector is powered by an internal Lithium-ion battery.

For instructions on how to charge the WM 08 Wireless Audio Module read [page 55](#). For instructions on how to charge the ML 80 Wireless Headphones read [page 57](#).

## Charging the Battery

 Going detecting with a fully charged battery is recommended. Typical battery runtime is approximately 12 hours.

EQUINOX Series detectors are supplied with a USB charging cable that features a snap-on magnetic connector.

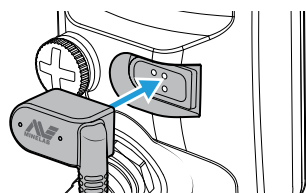

1. Plug the supplied charging cable into any standard powered USB-A port.
2. Connect the magnetic connector to the charging interface on the rear of the EQUINOX control unit.



The green charge status LED on the top left of the control panel will flash slowly.

3. When the battery is fully charged, the charge status LED will remain on.

### Charge Status LED

-  Charging (flashing)
-  Fully charged (on)

The charge time from completely flat to 100% is approximately 4 hours when a high capacity (>1.7A @ 5V) charger is used. Car and wall charging accessories are available for separate purchase.

Any standard USB port compatible with USB battery charging 1.2 (BC1.2) can be used to charge your battery, however charge times may be longer if using lower-power options.

If the detector is turned on during charging, the charge time will be longer.



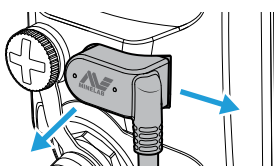

### Disconnecting the Charger



The charging cable can be removed from the charging interface by pulling it sideways, or by pulling it directly backwards.

## Battery Status Indicator

The battery status indicator shows the current battery level.

	70% – 100%
	30% – 70%
	<30%
	<5% (Charging required)

**bf** When the battery level is critically low, 'bf' will appear on the Target ID Display. The detector will then turn off automatically.

 The detector regulates the battery voltage so that its performance remains constant regardless of the charge remaining in the battery.

## Battery Maintenance

Lithium-ion battery performance may degrade if unused for long periods of time. Fully charge the battery at least once every 3–4 months to prevent this from occurring.

Even with correct care and maintenance, Lithium-ion battery performance reduces over time with normal use. Therefore the battery may need to be replaced every few years. Replacement batteries can be supplied and installed by an Authorised Service Centre.

## Operating With a Power Bank

 The detector must not be used underwater whilst charging or when connected to a power bank.

You can use your EQUINOX detector whilst plugged into a portable power bank. This means you can continue detecting even if the detector battery is flat.

Connect the power bank to your detector using the supplied EQUINOX USB charging cable, and continue detecting. You can fasten it to the armrest stand via the armrest attachment points.



# Control Panel

The EQUINOX control panel has a large monochrome LCD with a backlight, a keypad, and side buttons. These display and control all of the detector functions.

**Charge Status LED**  
Shows the charge status of the detector battery.

**Power Button**  
Turns the power on/off, and is used for Factory Reset.

**Backlight Button**  
Turns the backlight on/off and selects the backlight brightness.

**Detect Mode Button**  
Scrolls through the Detect Modes: Park, Field, Beach, Gold\*.  
Each Detect Mode has 2 customisable Search Profiles.

**All Metal Button**  
Toggles between the current discrimination pattern and All Metal to accept all targets.

**Pinpoint/Detect Button**  
Press when in the Settings Menu to return to the Detect Screen.  
Press while detecting to activate Pinpoint. Press again to return to the Detect Screen.

**LCD Screen**  
Large monochrome LCD with backlight.

**Wireless Audio Button**  
Activate Bluetooth® or Wi-Stream to connect wireless headphones or the WM 08 wireless audio module.

**User Profile Button\***  
Saves the current detector settings for future instant access.

**Settings Button**  
A short press of the Settings button accesses and scrolls through the Settings Menu.  
A long press when in the Settings Menu accesses Advanced Settings where available.

**Accept/Reject Button**  
Press when a detection occurs to reject the detected Target ID. Rejected Target IDs will not produce an audio signal when detected.  
Use to create discrimination patterns and adjust Tone Regions via the Settings Menu.  
Press when in the Iron Bias setting to toggle between Iron Bias FE and Iron Bias F2.

**Minus / Plus**  
Press when in the Detect Screen to adjust the Sensitivity level.  
Press when in the Settings Menu to adjust the value of the selected setting.

**Frequency Button**  
Select from the available frequency options:  
Multi, 4 kHz, 5 kHz, 10 kHz, 15 kHz, 20 kHz\* and 40 kHz\*.

## Screen Protector Application

Applying a screen protector will protect your screen against scuffing and scratching from normal use.

Additionally, the screen protector includes a text guide to help you learn the top level settings in the Settings Menu.



For screen protectors in languages you will not use, cut the black section off carefully with sharp scissors, and then apply as usual.

1. Remove the thin plastic film from the detector screen. Make sure the screen is clean and free of dust and fingerprints.
2. Peel the backing off of the screen protector, being careful not to touch the adhesive side.
3. Hold the edges of the screen protector, align it to the screen, and apply gently.
4. Wipe any bubbles to the edge with a soft, clean cloth.
5. Peel off the front layer.

# LCD Icons

All of the information you need to see during detecting and when adjusting your detector settings is displayed on the large LCD in the control panel.

**Battery Status Indicator**  
Displays the charge level of the battery. (page 8)

**Beach Overload Indicator**  
Indicates an automatically reduced transmit signal strength in order to prevent overload in Beach Mode in extreme conditions. (page 25)

**Pinpoint**  
Appears when Pinpoint is active. (page 19)

**Audio Connectivity**  
Displays the current wired and wireless audio devices connected to your detector. (page 53)

**Backlight**  
Appears when the backlight is on. (page 32)

**Tracking Ground Balance**  
Appears when Tracking Ground Balance is active. (page 40)

**Target ID Display**  
Shows the Target ID of a detected target. (page 30)  
*The Target ID Display also shows the values of detector settings as they are adjusted.*

**User Profile\***  
Appears when the saved User Profile is active. (page 33)

**Discrimination Scale**  
High resolution 50 segment (-9 to 40) Discrimination Scale for accurate, stable target identification. (page 30)  
*The Discrimination Scale indicates target signal strength when in Pinpoint. (page 19)*  
*It is also used to adjust Tone Regions for advanced audio settings.*

**Depth Gauge**  
Indicates the approximate depth of a detected target. (page 35)

**Frequency Display**  
Shows the current operating Frequency. (page 28)  
*The Frequency Display also shows error codes, indicates the selected Tone Region for Advanced Tone Settings, and indicates the active Iron Bias mode when adjusting the Iron Bias Setting.*

**Sensitivity Indicator**  
Indicates approximate Sensitivity level - 25 levels shown in increments of 5. (page 34)

**Settings Menu**  
Settings and Advanced Settings are in the Settings Menu. (page 37)

  
Setting

  
Advanced Setting

Setting	Advanced Setting
Noise Cancel	Tone Volume
Ground Balance	Threshold Pitch*
Volume Adjust	Tone Pitch
Threshold Level	Tone Break
Target Tone	Iron Bias
Accept/Reject	
Recovery Speed	

**Detect Modes**  
Displays the Detect Mode: Park, Field, Beach, Gold\*  
Each Detect Mode has 2 customisable Search Profiles. (page 22)

Detect Mode

  
Search Profiles

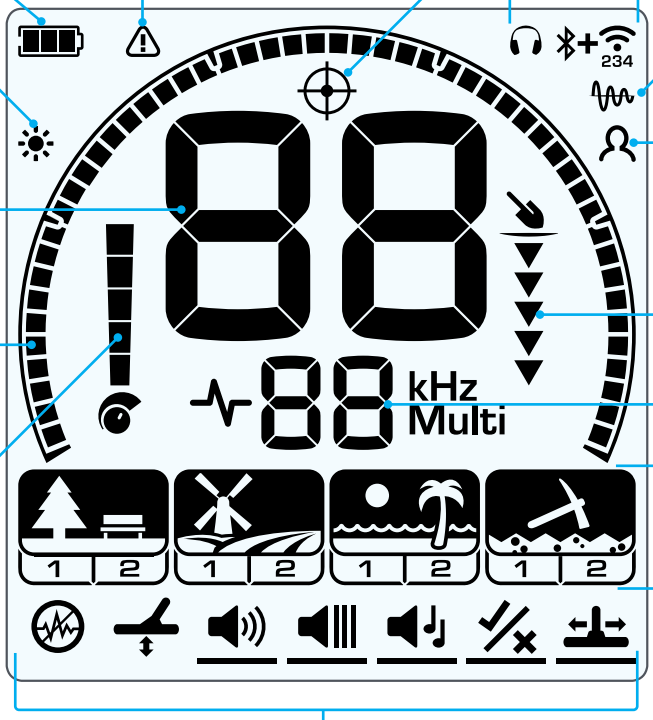

# Quick Start

EQUINOX is so easy to use, even a beginner can successfully begin detecting right out of the box. There are just 4 easy steps to get started.

 Before first use, it is recommended that you fully charge the battery for 4 hours. (page 8)

## 1

### Turn On

Press the Power button on the side of the control panel.



## 2

### Select a Detect Mode

Select the optimum Detect Mode Search Profile for your detecting location. (EQUINOX 800 shown).

See 'Detect Modes' on page 22 for more information on how to choose the most suitable Detect Mode.



## 3

### Noise Cancel

Select Noise Cancel from the Settings Menu, then press  to initiate an Auto Noise Cancel. This will take approximately 8 seconds to complete.



## 4

### Begin Detecting

Press  to return to the Detect Screen, and begin detecting.



 If excessive ground noise is heard after performing the Quick Start steps, carry out the Ground Balance procedure (page 40).

If excessive noise is still being experienced try adjusting the Sensitivity to a lower level to reduce noise (page 34).

# Global and Local Settings

When you are adjusting Settings and Advanced Settings, the icons of affected Detect Modes will appear on the LCD.

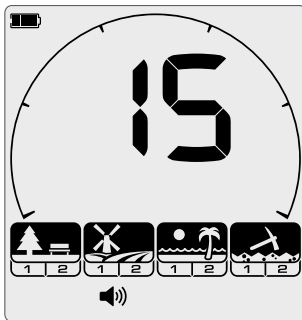

### Global Settings



Adjustments to some Settings and Advanced Settings are Global. All Detect Mode Search Profiles will be affected by changes to the setting.

*Global Settings e.g. Volume; All Detect Modes and Search Profile icons are on.*

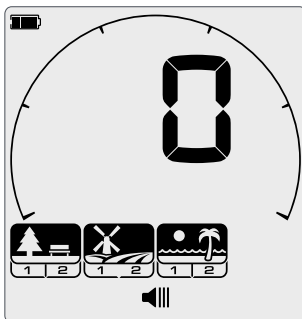

### Semi-Global Settings



For Semi-global Settings and Advanced Settings, Park Field, and Beach Mode Search Profiles all have the same setting, and Gold Mode Search Profiles have another.

*Semi-Global Settings e.g. Threshold Level; The Detect Modes and Search Profiles affected by changes are on.*

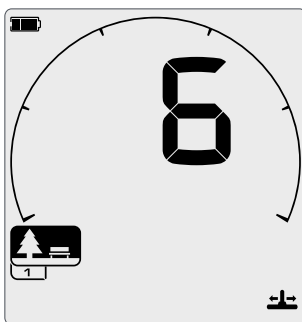

### Local Settings



Adjustments to some Settings and Advanced Settings are Local. Only the active Detect Mode Search Profile will be affected by changes to the setting.

*Local Settings e.g. Recovery Speed; Only the Detect Mode Search Profile affected by changes is on.*

### Global and Local Settings Reference

	<b>Frequency</b>	Local
	<b>Noise Cancel</b>	Local
	<b>Ground Balance</b>	Local
	<b>Volume Adjust</b>	Global
	<b>Tone Volume</b>	Local
	<b>Threshold Level</b>	Semi-global
	<b>Threshold Pitch*</b>	Semi-global
	<b>Target Tone</b>	Local
	<b>Tone Pitch</b>	Local
	<b>Accept/Reject</b>	Local
	<b>Tone Break</b>	Local
	<b>Recovery Speed</b>	Local
	<b>Iron Bias</b>	Local
	<b>Sensitivity</b>	Global
	<b>Backlight</b>	Global

## Reset a Search Profile

Individual Search Profiles can easily be returned to their factory preset settings. Only the local settings will be reset; any global settings will remain in their last-use state.

1. Navigate to the Detect Mode Search Profile you wish to reset.
2. Press and hold the Detect Mode button for 5 seconds.
3. The Mode icon will flash, 'SP' will appear on the Target ID Display, indicating that the Search Profile has been reset.



*'SP' will appear on the Target ID Display when a Detect Mode Search Profile is reset.*

4. Release the Detect Mode button. There will be a rising confirmation tone.

## Factory Reset the Detector

Factory Reset will return all detector settings and Detect Modes to factory preset values, and will unpair all wireless headphones.

1. Turn the detector off.
2. Press and hold the Power button for approximately 8 seconds. The start-up animation will display.
3. 'FP' will then appear on the Target ID Display, indicating that Factory Presets are restored.



*'FP' will appear on the Target ID Display when Factory Presets are restored.*

4. Release the Power button. There will be a rising confirmation tone.

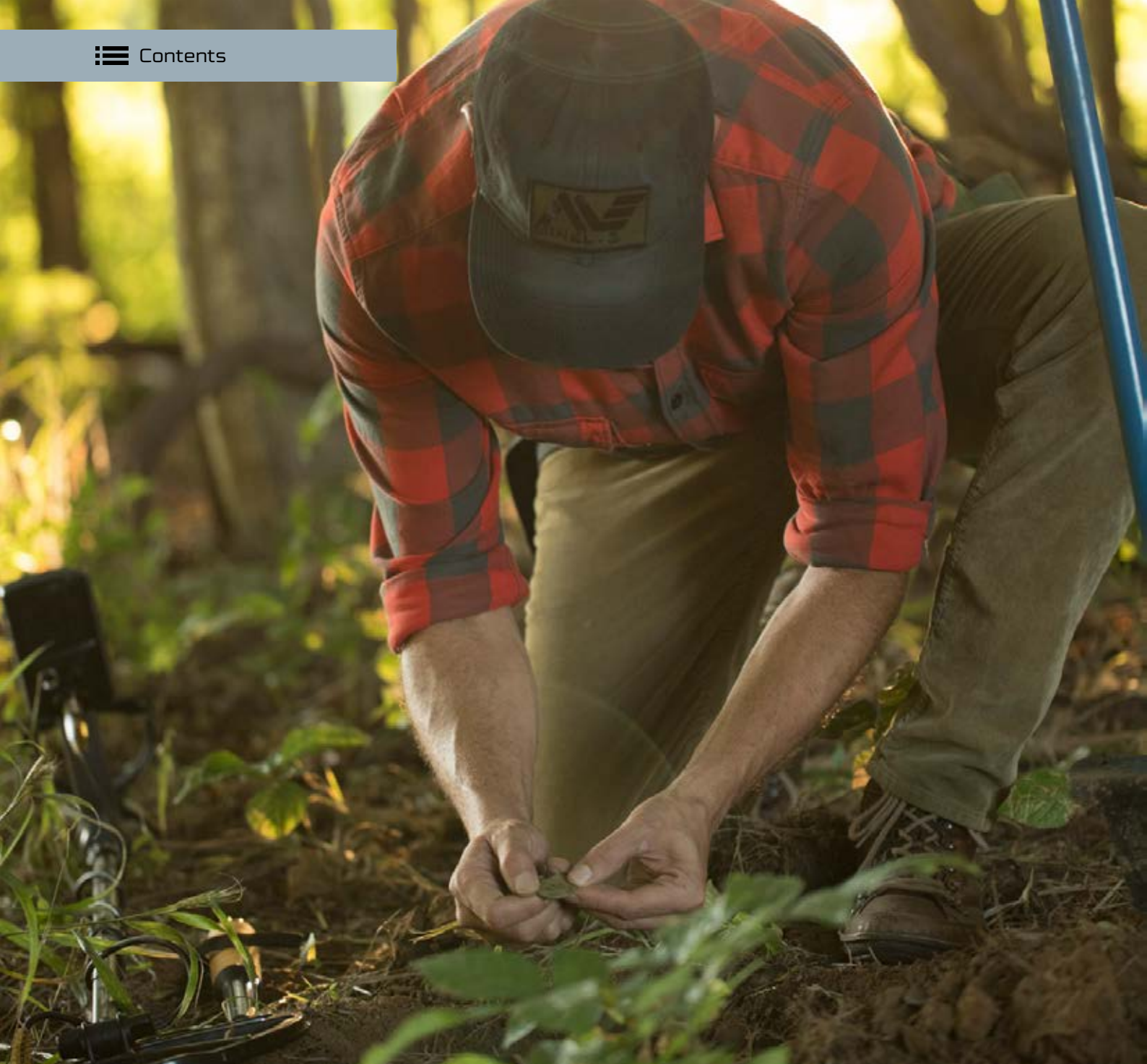

## Detecting Basics

This section contains great information for both new and experienced detectorists.

It explains basic detecting principles and techniques. You can learn how to set up your detector for maximum comfort and ease of use.

# How Detectors Work

Metal detectors create an electromagnetic field which penetrates the ground. Metal objects cause a change to this field because they conduct electricity. The detector senses this change and sends a signal back to the control unit, alerting the operator.

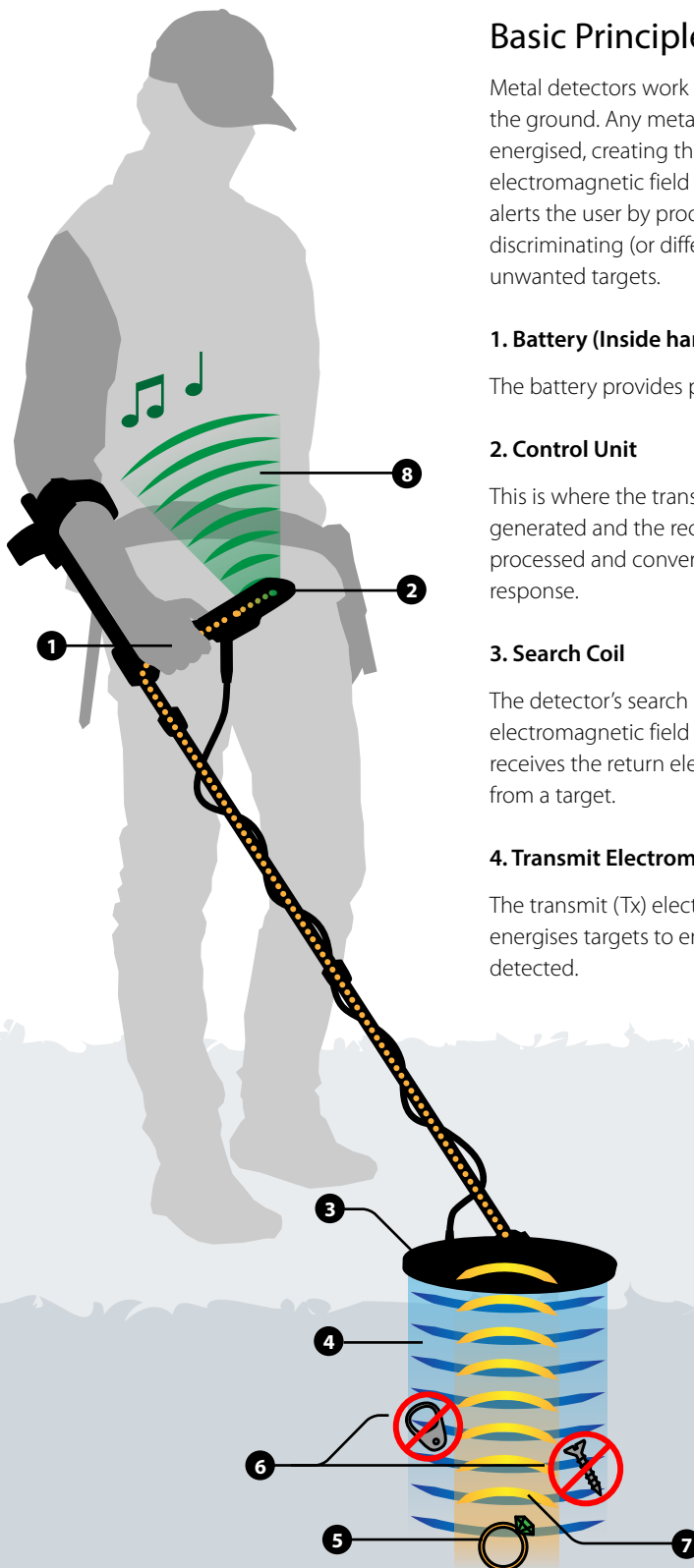

## Basic Principles

Metal detectors work by transmitting an electromagnetic field from the search coil into the ground. Any metal objects (targets) within this electromagnetic field will become energised, creating their own circular electric currents (eddy currents) and transmit an electromagnetic field of their own. The detector's search coil senses this receive signal and alerts the user by producing a target response. Minelab metal detectors are also capable of discriminating (or differentiating) between different target types and can be set to ignore unwanted targets.

### 1. Battery (Inside handle)

The battery provides power to the detector.

### 2. Control Unit

This is where the transmit signal is generated and the receive signal is processed and converted into a target response.

### 3. Search Coil

The detector's search coil transmits the electromagnetic field into the ground and receives the return electromagnetic field from a target.

### 4. Transmit Electromagnetic Field (blue)

The transmit (Tx) electromagnetic field energises targets to enable them to be detected.

### 5. Target

A target is any metal object that can be detected by a metal detector. In this example the detected target is treasure, which is a good (accepted) target.

### 6. Unwanted Targets

Unwanted targets can be ferrous (iron), such as nails, and can also be non-ferrous, such as pull-tabs. If the metal detector is set to reject unwanted targets then a target response will not be produced for those targets.

### 7. Receive Electromagnetic Field (yellow)

The receive (Rx) electromagnetic field is generated from energised targets and is received by the search coil.

### 8. Target Response (green)

When a good (accepted) target is detected the metal detector will produce an audible response, such as a beep or a change in tone, and a visual display of target information will be shown on the screen.

## Key Detecting Concepts

It is beneficial to understand a few key metal detecting technology principles so that you can select the best settings for different detecting conditions.

→ For a complete glossary of detecting terms, visit [www.minelab.com/knowledge-base/getting-started/glossary-of-terms](http://www.minelab.com/knowledge-base/getting-started/glossary-of-terms).

### Frequency

The operating frequency of a metal detector is one of the main characteristics that determines how well targets can be detected.

The frequency of a detector is the number of times a signal is transmitted into the ground per second, and is measured in Hertz (Hz). 1000 Hz = 1 kHz.

EQUINOX is unique in that it offers both multi-frequency and single frequency operation. Read 'Frequency' on page 28 for more information.

Find out more about the EQUINOX Multi-IQ technology on the [Minelab Treasure Talk blog](#).

### Ground Balance

Ground Balance is a variable setting that improves detection depth by reducing noise in mineralised ground. Mineralised ground may contain salts, e.g. wet beach sand, or fine iron particles, e.g. red soil. These minerals respond to a detector's transmit field in a similar way that a target does. Due to the much larger mass of the ground compared to a buried target, the effect of mineralisation can easily mask small targets.

EQUINOX has different Detect Modes (Park, Field, Beach, Gold\*) to cope with typical ground conditions.



A Ground Balance setting is also available, read 'Ground Balance' on page 40 for further information.

## Detection Depth Factors

The most common question about metal detectors is "How deep do they go?"

The simple answer is "as deep as the diameter of the coil for a coin-sized target". Therefore detectors with larger coils will detect deeper. However, detection depth also depends upon detector technology and many environmental factors. A more complete answer is usually more complex, and starts with "It depends..." The depth that a metal detector can detect a target depends on a number of factors:

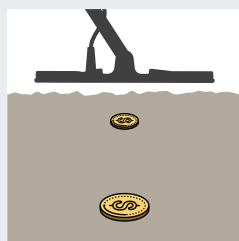

#### Target Size

Large targets can be detected deeper than small targets.

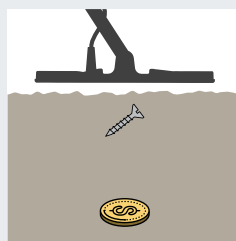

#### Target Shape

Circular shapes (e.g. coins and rings) can be detected deeper than long thin shapes (e.g. nails or screws).

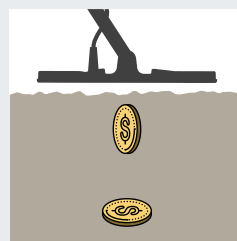

#### Target Orientation

A horizontal coin (e.g. lying flat) can be detected deeper than a vertical coin (e.g. standing on its edge).

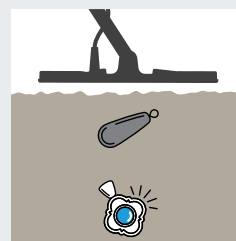

#### Target Composition

Highly conductive metals (e.g. silver) can be detected deeper than less conductive metals (e.g. lead).

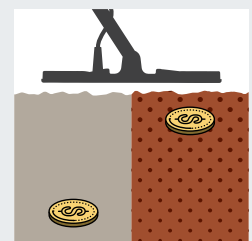

#### Ground Mineralisation

A target in benign (unmineralised) ground can be detected deeper than a target in heavily mineralised ground.

## Detecting Technique

Correct detecting technique is important to get the most out of your detector. The techniques described will give you the best chance of success.

### Holding the Detector

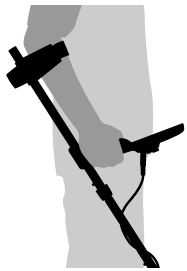

Insert your arm through the armrest and armrest strap. Grasp the handle of the detector and rest your forearm in the armrest.

The correct position of the armrest should allow you to comfortably grip the handle. Your elbow should sit just above the back of the armrest and the detector should feel like an extension of your forearm.

### Adjusting the Length of the Shafts

The lower shaft can be adjusted to several set lengths between fully extended and fully retracted. Adjust the lower shaft to the correct length and tighten the twist lock to hold it in place.

A correct shaft length will allow you to swing the coil over the ground without uncomfortably stretching or stooping. If the coil is too far from your body it will be difficult to balance and manoeuvre while detecting. If the coil is too close to your body it may detect your digging tools or any other metal which you are carrying, causing confusing sounds.

### Adjusting the Angle of the Coil

1. Loosen the yoke nut and bolt that fastens the lower shaft to the coil. It should be loose enough to allow the coil to be moved for adjustment, but tight enough that the coil can hold its position.
2. While holding the detector in the detecting position, lightly press the coil to the ground until it sits flat/parallel with the ground. The coil should remain parallel when lifted to the sweep height, approximately 25 mm (1-inch) above the ground.
3. Tighten the yoke nut just enough to hold the coil in position.

### Sweeping the Coil

EQUINOX Series detectors are motion detectors, meaning that the coil must be moving across the ground in order to detect a target. If the coil is held stationary over a target, it will not be detected. The side-to-side detecting motion is called 'sweeping' or 'swinging', and with practice will become a comfortable and fast way to cover ground.

Sweeping the coil incorrectly can cause you to miss targets or can generate false signals.

Though the coil assembly is rigid and durable, sudden jolts or bangs may cause random signals and inaccurate Target IDs, as well as excessive wear and tear. Careful sweeping will ensure the coil performs to an optimum level at all times.

### Sweep Parallel to the Ground

You will obtain the best performance when the coil is swept close and parallel to the ground at all times. This will maximise detection depth and improve the response to small objects. Avoid excessive brushing of the coil on the ground.

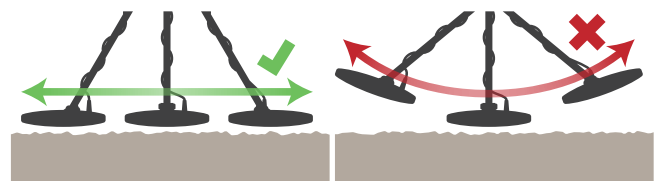

### Overlap Your Sweep

Practice sweeping the coil over the ground in a side-to-side motion while slowly walking forward at the end of each sweep. Slightly overlap the previous sweep to ensure full ground coverage. An average sweep speed is 2 to 3 seconds from right-to-left-to-right.

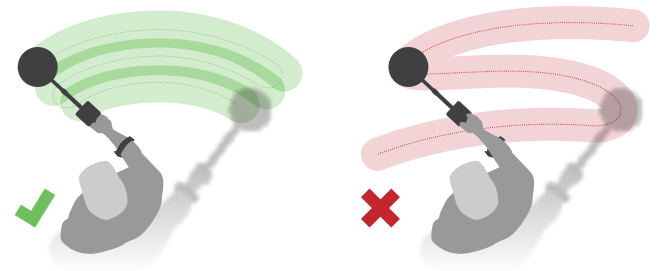

### Targets

Metal objects are referred to as targets. Targets are comprised of ferrous and non-ferrous metals. Ferrous metals are those containing iron such as steel, nails and some types of coins. Non-ferrous metals are those which are not magnetic, such as gold, silver, copper, bronze and aluminium.

You may wish to find a range of both ferrous and non-ferrous targets.

### Examples of Common Targets:

- Desired ferrous target – war artefact
- Undesired ferrous target – iron nail
- Desired non-ferrous target – gold coin
- Undesired non-ferrous target – pull-tab



# Detector Sounds

The EQUINOX produces a variety of different sounds for target and environmental signals and various detector functions.

## Targets

A target signal is the sound produced by the detector when any metal object is detected.

Typically, a ferrous (iron) target gives a low tone response and a non-ferrous target gives a higher tone response that varies according to the conductive properties of the metal (e.g. silver will give a higher tone than aluminium).

### Volume and Target Proximity

Large targets and targets close to the ground-surface give louder audio signals.

Signals produced by targets a long way from the coil are quiet, becoming rapidly louder as the coil nears the target.

EMI can also be received from other metal detectors operating nearby. Always detect a minimum of 15 metres (45-feet) away from other detectors.

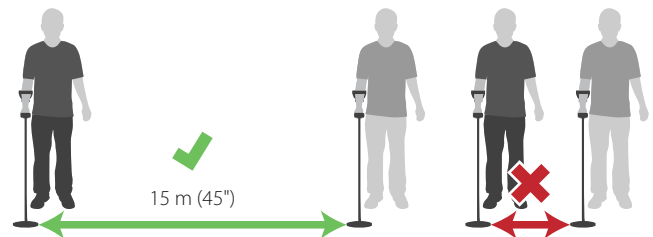

 EQUINOX should not be operated indoors. Metal in the floors and walls, and household appliances will cause significant noise interference.

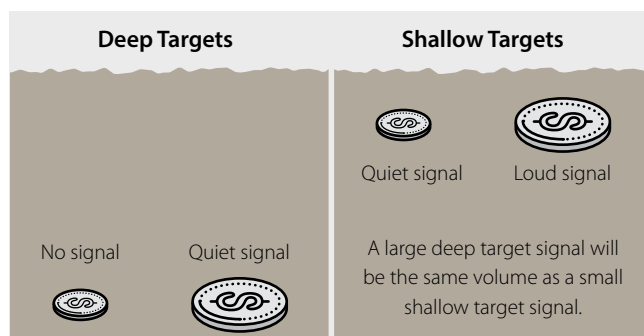

The sound produced by the detector in Pinpoint or Ground Balance will vary in volume and pitch depending on the signal strength (from a target or ground mineralisation). This volume range is proportional to the maximum volume setting.

## Noise/False Signals

The detector may pick up unwanted noise signals, either through the air or from the ground. These false signals can be reduced by using Noise Cancel or Ground Balance. Turning down Sensitivity will also allow you to operate the detector effectively in difficult (or noisy) locations.

### Electrical Noise

Electromagnetic Interference (EMI) may occur near power-lines, phone towers or electric fences. This can cause a detector to perform erratically, causing false signals and inaccurate Target ID.

The effects of electrical noise can be reduced using Noise Cancel (page 39).

### Ground Noise

Ground interference (or ground noise) may occur when there are high levels of mineralisation in the soil. This can be very common in detecting locations, especially goldfields.

The effects of ground noise can be reduced using Ground Balance (page 40).

## Keypad

The detector will make a sound whenever buttons on the keypad are pressed. A valid button press makes a short high pitched 'bip' sound. An invalid button press makes a low pitched beep.

## Threshold

The constant background 'hum' that can be produced by the detector is called the Threshold. Some users like to hear a threshold tone so that they can hear both target signals and rejected target audio 'blinking'.

When a rejected target is detected, the Threshold 'blanks' (becomes silent), indicating that a target is located underneath the coil, but has been rejected by the discrimination pattern.

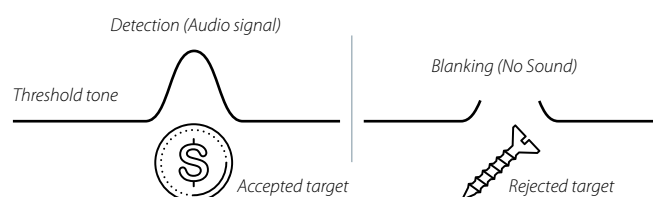



## Simple Detecting Exercise

Before attempting to find real targets, it is important to understand how to interpret the audio and visual signals of the detector.

1. Gather a collection of different metal objects, e.g. various coins, gold and silver jewellery, a nail, a pull-tab, a brass button and aluminium foil.
2. Take the detector outdoors, away from known sources of electromagnetic interferences (EMI) and metal objects.
3. Lay the objects in a line, sufficiently spaced apart to allow the coil to pass between them.
4. Sweep the coil across the test targets one at a time. Observe the Detect Screen and listen to the sounds of the detector as it passes over each object. The Detect Screen and audio response will give you detailed information about the Target ID.

Don't worry if the detector is not producing a sound over the nail — this is because the detector begins in the default Park Mode Profile 1, which rejects signals from common trash targets, including ferrous targets.

If you are getting signals from a clear patch of ground, there could be buried metal objects. Try finding a different area.

-  You may like to make a record of the Target IDs for each of your targets.
-  When you go detecting, always carry a 'test target' with you, e.g. a coin, which is similar to the targets you are looking for.

Bury it at around 4 – 6 inches within your detecting location and adjust your EQUINOX settings until the desired response is heard over the test target.

This way you are guaranteed to detect the same types of targets if they are there. Remember to dig up your test target after you are finished.



Nail or Screw



Pull-Tab



Tiny Coin



Fine Gold Ring



Small Coin



Large Coin

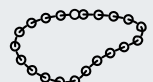

Heavy Silver Chain

# Pinpointing Technique

A good pinpointing technique helps you to quickly narrow down the location of a buried target, allowing you to determine its exact location before digging.

By combining a good pinpointing technique with the EQUINOX Pinpoint function, you will be able to accurately locate a buried target within an area before you dig.



For additional information on Pinpointing with the help of the Pinpoint function, read 'Pinpoint' on page 36.

It is possible to pinpoint a target successfully without using Pinpoint, however this requires practice.

## Coil Configuration and Pinpointing

The standard EQUINOX Series EQX 11 detector coil has a wire winding configuration known as Double-D.

When pinpointing, it is useful to know that a Double-D coil has two overlapping wire windings in the shape of two D's. The regions created by the overlapping windings (running from the front centre of the coil to the back) is the most sensitive area and will give the loudest response when a target is directly beneath it.



The line shows the strongest signal zone on the EQX 11 coil. This is also the same for all EQX Double-D accessory coils.



Front view of the Double-D strongest signal profile.



The strongest signal occurs where the Tx and Rx coil windings overlap.

The benefits of this configuration include lower noise susceptibility (especially in mineralised ground), higher sensitivity, and a very thorough search pattern requiring less sweep overlap.



Double-D coils may produce complex signals from shallow targets. Sometimes three separate signals can be heard for a single target as the coil is swept over it.

## Pinpointing a Target Manually

1. Sweep the coil slowly across the target location keeping the coil parallel to the ground.
2. Locate the centre of the target by listening for the loudest target signal response.
3. Make a mental note of the position, or mark a line on the soil with your shoe or a digging tool.
4. Move to one side so that you can pass the coil over the target at right angles to your initial direction.
5. Line up the target at 90° from the initial direction and repeat the process. The object is located where the two imaginary lines cross.

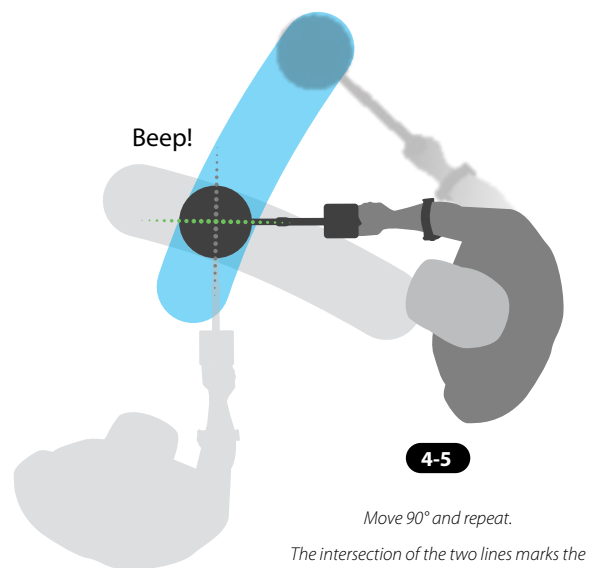
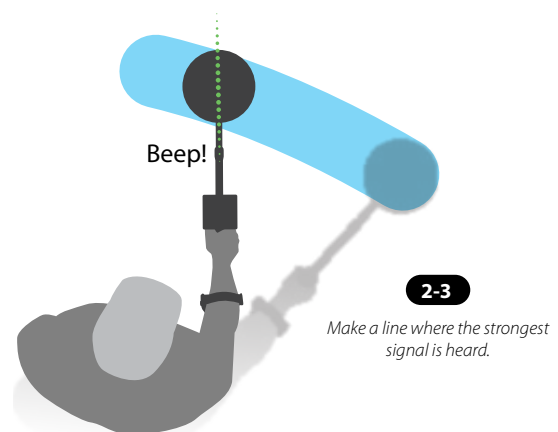

# Target Recovery

Using the right tools and a good target recovery technique is important to prevent damage to a buried target, which could significantly reduce its value.

## Digging Tools

Different detecting locations have different types of ground, so you will need to take the right tools with you. You may wish to use a combination of tools when you dig to speed up the recovery process.

Buy the best quality digging tools you can; Purchase them from a detecting specialist, as tools found in hardware stores can be inadequate for recovering a target and vary widely in quality.

You don't want to be out on a detecting trip with a broken digging tool.

### Park



In Park locations, a digging knife with a serrated edge is great for cutting through turf and fine roots to form a neat plug of earth. A small strong spade is useful for digging bigger holes for deeper targets.

### Field



Field locations are often composed of dense clay soil that will clump together. A small strong spade is useful for digging bigger holes for deeper targets.

### Beach





Typical sandy Beach locations mean targets can be easily recovered with the use of a plastic scoop, or even your hands. A long handled sand scoop is required for recovering submerged targets from the water.

### Gold\*



In typical Gold locations, a small pick will help to break open the earth, while a plastic scoop will assist with checking the soil for gold nuggets without damaging them.

## Recovering a Target

-  Be sure not to wear rings, bracelets or a watch, as they will produce a signal when you are recovering targets.
-  A Minelab PRO-FIND Series pinpointer is another useful tool for quickly narrowing down the location of a buried target within a hole.

1. Once a target has been pinpointed, clear the ground surface of loose material and check the ground again for a signal. If there is no signal, then the target is amongst the surface material. If the target is still in the ground, Pinpoint again.
2. Try to leave the ground exactly as you found it. Using a sharp tool, cut a neat plug, leaving some grass attached on one side like a hinge. Lift the plug out and over. This prevents soil from being scattered and allows the hole to be refilled quickly.
3. Check the hole for the target. If the target is not in the hole, place the detector on the ground with the coil flat. Pick up a handful of soil and pass it over the coil, returning soil to the hole after you have checked it. Repeat this procedure until the target is located.
4. Check that no other targets remain in the hole. Refill the hole with all soil and grass as neatly as possible. Step lightly on the soil to compact it.

Leaving holes or a scarred area may result in action being taken to prevent the use of metal detectors. Please ensure that the area of ground is left as you found it, and remove all rubbish.

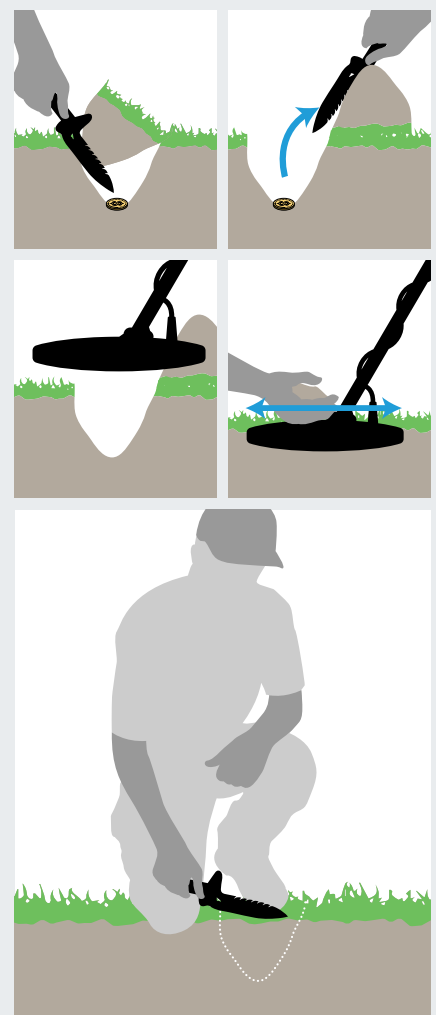

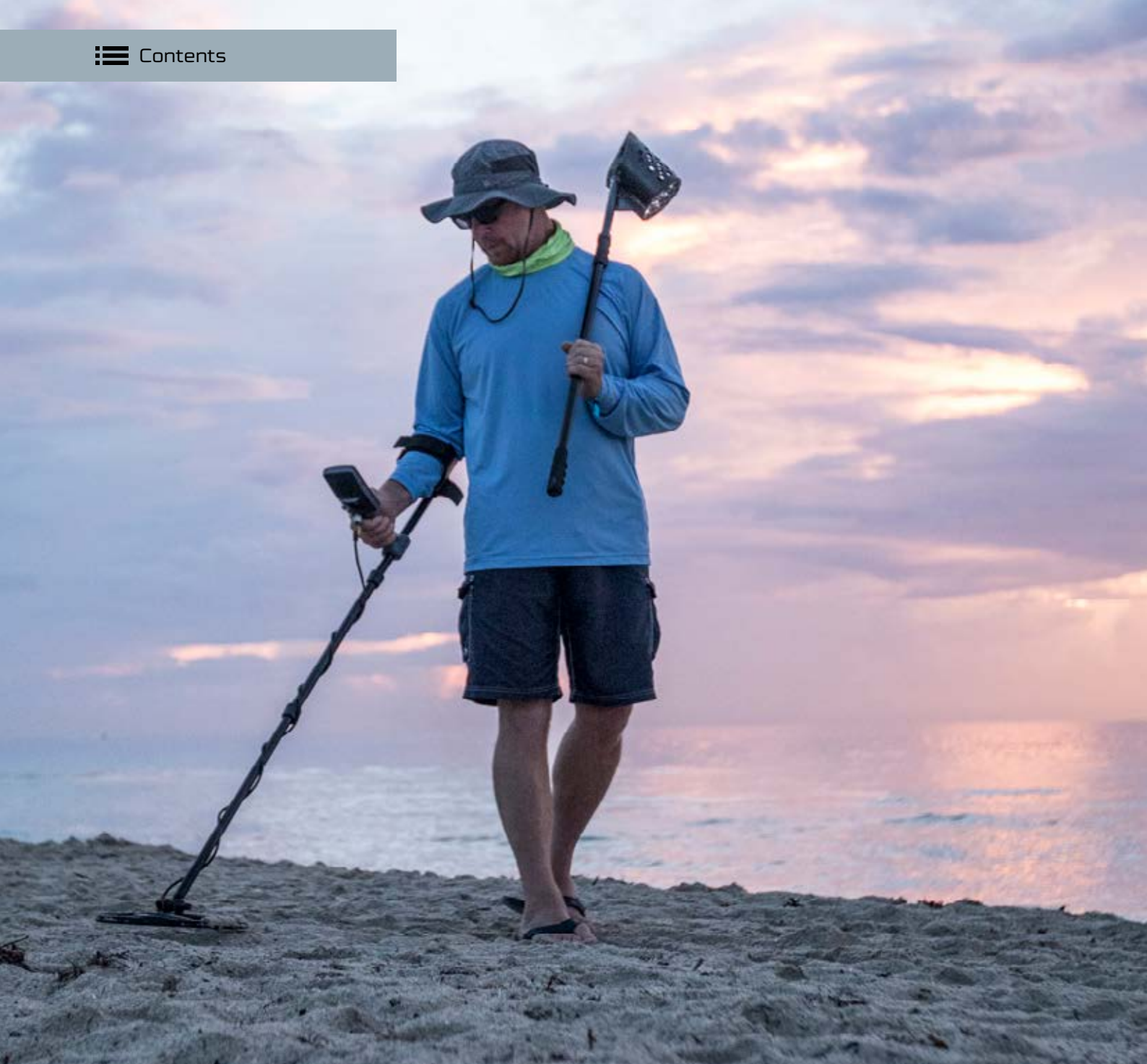

## Detect Modes

EQUINOX is equally adaptable for all target types and ground conditions... just select your detecting location and go.

Detect Modes are based on common detecting locations, making it easy for anybody to confidently choose the right Mode for their detecting session.

This section explains the differences between the Detect Modes, and includes some great tips to help you master each Mode.



The Detect Mode descriptions in the following section are for typical detecting locations. Some Detect Modes will be useful in locations not represented by the Mode name, icon, or description.

# Detect Modes

EQUINOX Series redefines all-purpose detecting, with Detect Modes that are based on common detecting locations. Simply select the best match and begin detecting.

EQUINOX Series features Detect Modes, each representing a common detecting use: Park, Field, Beach, and Gold\*.

Each Detect Mode has two Search Profiles.



Each Search Profile has been pre-configured to optimise the detector for best performance in the conditions typical to that location. Each of the pre-configured Profiles can be modified and saved.

EQUINOX remembers its last-used Search Profile and will return to this when the detector is turned on. For example, if Field Profile 1 was active when turned off, this Search Profile will be active when the detector is turned back on.

## Detect Mode Navigation



Detect Mode Search Profiles can be cycled through by pressing the Detect Mode button.

Each press will scroll to the next Search Profile in a left-to-right direction. When the last Search Profile is reached, another press of the Detect Mode button will return you to Park 1.



## Adjusting Search Profiles

Save your favourite detecting settings in Profile 1 or 2 in each Detect Mode once you are familiar with the detector.

Remember, some settings are global (page 12) and will be adjusted for all Search Profiles when a change is made.

For the complete list of the factory presets for each Detect Mode Search Profile, read 'Factory Presets' on page 62.

### To Adjust a Search Profile:

1. Navigate to the Detect Mode Search Profile you wish to adjust.
2. Make the adjustments to the Settings and Advanced Settings for that profile. They will be automatically saved.
3. Next time that Search Profile is selected, the local settings you selected will be remembered.

If you want to restore the preset state of an individual Detect Mode Search Profile, see 'Reset a Search Profile' on page 12.













To factory reset all detector settings and Detect Modes, see 'Factory Reset the Detector' on page 12.

## Choosing the Right Detect Mode

Choosing the right Detect Mode is important to get the best performance for the environment you are detecting in. To easily get started, choose Park, Field, Beach or Gold\* to suit your location.

Search Profile 1 is suitable for general conditions. Search Profile 2 is optimised for more difficult conditions. Target sensitivity is enhanced, but extra noise may also result.

Detailed descriptions of each Detect Mode are in the following pages.

 <b>Park</b>		 <b>Field</b>		 <b>Beach</b>		 <b>Gold*</b>	
Great for high-trash recreational areas, including most general detecting.		Ideal for detecting in historical fields for the widest range of target sizes.		Optimised for all salty conditions – dry sand, wet sand, surf, and underwater.		Best suited for gold nugget prospecting in mineralised goldfield locations.	
							
General / Coins	Fine Jewellery	Coins / Artefacts	Fine Coins / Artefacts	Wet / Dry Sand	Underwater / Surf	Normal Ground	Difficult Ground

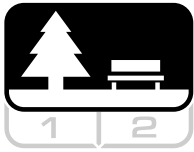

## Park

Great for high-trash recreational areas, including most general detecting.

**Park Mode** is for searching in urban parks, or other recently inhabited sites where there may be coins and jewellery. There is often also lots of common metal litter including aluminium foil, pull-tabs, bottle-caps etc. Park Mode is a good starting point for other general uses, such as freshwater detecting, or use for artefact hunting by accepting all ferrous Target IDs.

Park Mode default settings will provide great depth, accurate target resolution and sufficient discrimination in trash-cluttered areas typical of recreational parks. With Frequency set to Multi, Park Mode will be the most sensitive to a wide range of targets, while rejecting much of the trash. If in doubt in a new area, or when first detecting, try Park mode first.



### Park 1: General / Coins

Park 1 is optimised for modern coins and larger jewellery with a default discrimination pattern set to reject many common aluminium foil-like targets (Target ID 1). Therefore this is the ideal profile to start with to learn EQUINOX, before experimenting with the other Modes and more specialist settings.

Park 1 Multi-IQ processes a lower frequency weighting of the multi-frequency signal, as well as using algorithms that maximise ground balancing for soil, to achieve the best signal to noise ratio. Hence Park 1 is most suited for general detecting and coin hunting.



### Park 2: Fine Jewellery

Park 2 is better suited for smaller targets and greater trash densities. It will detect a wider range of targets including low conductors (or higher frequency) targets, e.g. fine jewellery. All non-ferrous targets are accepted by default. Recovery Speed is also increased to clearly identify good targets masked by iron trash.

Target Tone is set to 50 to allow greater audible target identification rather than relying more heavily on the visual Target IDs. Park 2 Multi-IQ processes a higher frequency weighted multi-frequency signal while ground balancing for soil.

## Park Detecting Hotspots

In order to maximise your detecting success, keep an eye out for areas where people gather. These may include park benches or under trees and other shady spots where people have been sitting, or at recreation grounds near clubrooms or spectator stands.

After festivals or events, there are often many objects to find (especially coins that have been dropped), but you may be in competition with other detectorists. Always make sure you are allowed to detect in public parks, recreation areas and private property.

## Difficult Areas - Aluminium Foil

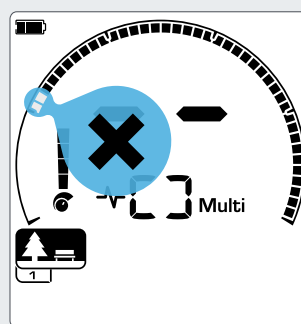

Reject Target IDs 1 and 2 in the discrimination pattern for Park Mode Search Profiles.

Modern parks typically contain a high amount of aluminium shards from discarded trash (e.g. drink cans, pull tabs, ring pulls, etc.) As aluminium is a non-ferrous very low conductive target, its Target ID falls within the same range as fine jewellery.

Park 1 is a good option in highly contaminated parks. Rejecting Target IDs 1 and 2 (or higher if the unwanted aluminium is larger in size) may also help with digging less trash.





## Field

Ideal for detecting in historical fields for the widest range of target sizes.

**Field Mode** is for searching open pasture, cropped or ploughed fields and historically occupied sites. These environments generally contain ferrous trash and coke from previous human occupation. In highly infested sites, Field Mode is well suited for rejecting coke and detecting hammered coins and ancient artefacts amongst the iron trash.

With Frequency set to Multi, Field Mode will be the most sensitive to the widest range of targets and more accurately identify objects at the limits of detection depth, compared to all single frequency options.



### Field 1: Coins / Artefacts

Field 1 is for general hunting with high trash rejection. This assists in locating desired targets more easily. The default discrimination pattern is set to reject Target IDs 1 and 2 (most coke signals).

The first Tone Break is set so that Target IDs 1 and 2 will produce the same low tone as ferrous targets. Field 1 Multi-IQ processes a lower frequency weighted multi-frequency signal, as well as using algorithms that maximise ground balancing for soil, to achieve the best signal to noise ratio. Hence being most suited for general detecting and coin hunting.



### Field 2: Fine Coins / Artefacts

Field 2 suits locations with high target and trash densities. It will better detect small hammered coins on their edge or at greater depth. The default discrimination pattern is set to reject Target IDs 1 and 2 (most coke signals).

Target Tone is set to 50 tones to enhance audio identification and Recovery Speed is faster. The first Tone Break has been set so that Target IDs 1 and 2 produce the same low tone as ferrous targets. Field 2 Multi-IQ processes a higher frequency weighted multi-frequency signal while ground balancing for soil.

## Difficult Areas - Coke

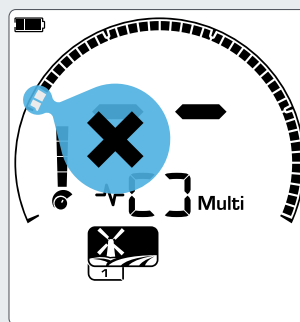

Rejected Target IDs 1 and 2 in the discrimination pattern for Field Mode Search Profiles.

Coke is the charcoal and carbon by-product of burnt coal, and is prevalent around historically populated areas.

Generally coke has a Target ID of 1 or 2. For this reason it is rejected by default in Field Mode. Note, this could result in some small non-ferrous targets being missed.

Field 1 Multi-IQ, even with Target IDs 1 and 2 accepted, will reject more coke more than Field 2 using Multi-IQ.





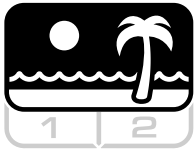

## Beach

Optimised for all salty conditions – dry sand, wet sand, surf, underwater.

**Beach Mode** is for salt water beaches including dry sand, wet sand, surf and underwater conditions. The salt that is typically present causes the sand and water to be very conductive, causing salt noise to be detected. Multi-IQ is better able to reduce this noise than any single-frequency can. Therefore Multi is the only Frequency option.

Beach Mode specifically identifies any residual salt response and assigns a ferrous Target ID - indicating that it's an unwanted target – so that desirable low conductive targets (such as gold chains) can readily be detected with minimal interference from the salt water.

The Recovery Speed is relatively high to further reduce unwanted salt-water signals, without greatly sacrificing detection depth.



### Beach 1 — Wet / Dry Sand

Beach 1 is most useful for detecting in wet/dry beach sand and also in shallow water where conductive salt signals are prevalent. It has good sensitivity to coins and small/large jewellery. Beach 1 reduces the salt signal, while maintaining high transmit power, and still being sensitive to desirable targets. Beach 1 Multi-IQ processes a low frequency weighted multi-frequency signal, and uses special algorithms to maximise ground balancing for salt.



### Beach 2 — Underwater / Surf

Beach 2 gives the best results when either wading or shallow diving, with the coil and/or detector fully submerged. In these instances, there is a very strong salt signal present, so Beach 2 has a lower transmit power, which results in much less noise. This profile may also be useful in dry conditions where there are extremely high ground noise levels. Beach 2 Multi-IQ processes a very low weighted multi-frequency combination, using the same algorithms as Beach 1 to maximise ground balancing for salt.

## Beach Detecting Hotspots

There are good chances of finding coins and jewellery under jetties and board-walks, beside steps and entry ways to and from the beach.

Locate the areas where people swim the most and detect in the deeper water there. Venturing into the water can give you an advantage over other detectorists who remain on the sand. Research shipwrecks if you are interested in historical finds.

Occasionally, the top layers of sand will be washed away by stormy weather conditions, exposing some deeper layers that often contain good targets.

## Difficult Areas – Black Sand

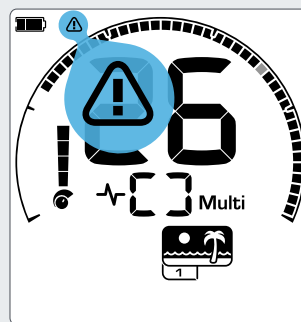

The Beach Overload Indicator will appear when the transmit signal strength is automatically reduced.

Some beaches contain black sand, which has high natural iron content and is often magnetic. This causes continuous false ferrous detections, making normal beach detecting impossible.

Beach Mode automatically senses black sand and reduces the transmit power to ensure that targets can still be detected without overloading occurring. When black sand is sensed, the Beach Overload Indicator will appear on the LCD. When this icon disappears, full transmit power automatically resumes.



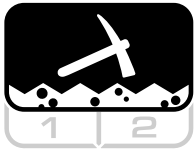

## Gold\*

Best suited for gold nugget prospecting in mineralised goldfield locations.

**Gold Mode\*** is for gold nugget prospecting. Generally, gold nuggets are found in remote goldfields where targets are more sparsely located.

Gold Mode\* uses a special audio that has a continuous sound, with more subtle variation than the other Detect Modes. This audio signal begins when the coil first approaches the target and then continues until the coil moves away. During the detection period, the signal volume and pitch vary proportionally to the strength of the target signal.

Gold Mode is ideally suited to finding smaller surface gold nuggets (and some larger deeper ones) that are present in mineralised ground.



### Gold 1 — Normal Ground

Gold 1 is suitable for searching for small gold nuggets in 'mild' ground. Most goldfield locations have a variable level of iron mineralisation that will require an ongoing Ground Balance adjustment, therefore Tracking Ground Balance is the default setting. Target Tone is set to 1 and the audio is optimised for hunting for gold nuggets.

Gold 1 Multi-IQ processes a high frequency weighted multi-frequency signal, while ground balancing for mineralised soil.



### Gold 2 — Difficult Ground

Gold 2 is best for searching for deeper gold nuggets in 'difficult' ground conditions. Gold 2 has a lower Recovery Speed, which will increase detection depth. However, more ground noise in more heavily mineralised grounds may result. Tracking Ground Balance is the default setting. Target Tone is set to 1 and the audio is optimised for hunting for gold nuggets.

Gold 2 Multi-IQ processes a high frequency weighted multi-frequency signal, while ground balancing for mineralised soil.

## Gold Detecting Hotspots

The best places to go detecting for gold nuggets are where gold has previously been found. Surrounding areas with very similar geology are also worth exploring. Many government mining agencies publish maps of goldfields locations and offer advice on obtaining relevant fossicking or hobby prospecting licences.

Some specific areas for gold prospecting include tailings from goldmine sites, old diggings from the 1800s, in (and near) streams where gold panning is carried out, arid dry-blowing locations and old reef mine dumps and slopes.

## Difficult Areas - Hot Rocks

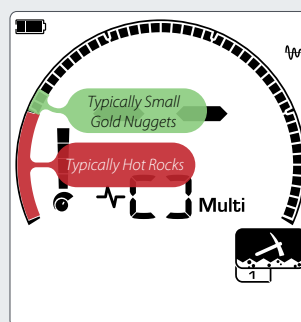

Target IDs 1 and 2 often indicate low conductive small gold nuggets. Hot rocks are generally found in the ferrous range.

'Hot' rocks are commonly found in gold prospecting locations. These are rocks that are mineralised differently to the surrounding ground. A highly mineralised rock buried in mildly mineralised ground would be considered to be a hot rock.

Hot rocks can easily be mistaken for gold nuggets. The Target ID can assist here, with hot rocks typically having a negative Target ID number and gold having a positive ID in the very low conductive range.



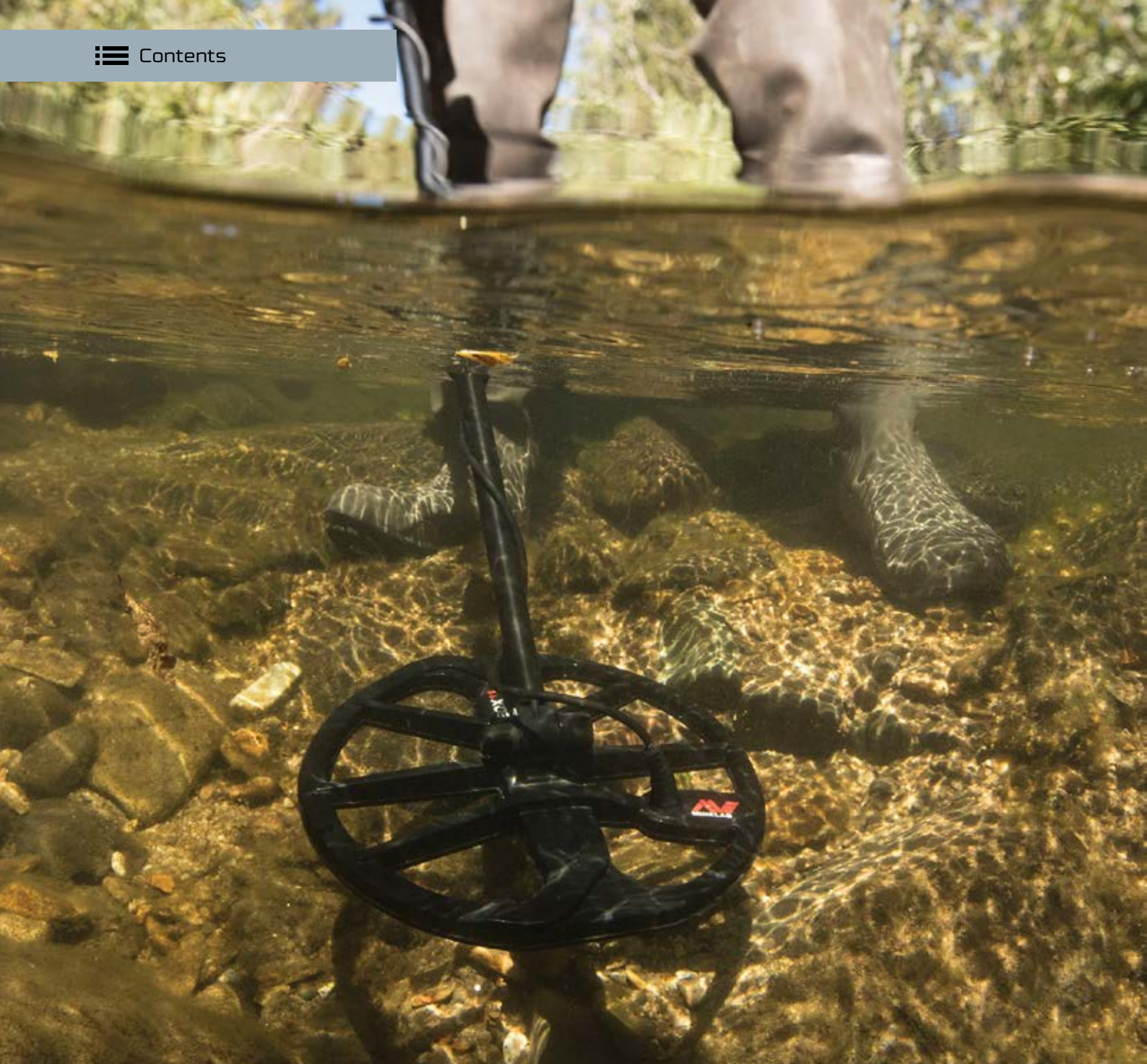

## Detect Screen Functions

The Detect Screen will be displayed while you are actively detecting. Key detecting information can be viewed and adjusted on-the-go.

Detect Screen functions are the detector settings or status displays that are accessible when you are in the Detect Screen.

# Frequency

With EQUINOX you can operate across a wide spectrum of frequencies simultaneously for maximum results, or you can operate in a single frequency.



EQUINOX Series detectors have simultaneous multi-frequency capability with a technology called Multi-IQ, as well as a selection of single frequencies.

 *Frequency adjustment is local; only the current Detect Mode Search Profile will be affected by changes to this setting.*



## Changing the Frequency

The operating frequency is easily changed and has a dedicated button on the control panel.

 Press the Frequency button to advance to the next available frequency. The Frequency will be shown on the Frequency Display.

 **Multi**  
*Displays a rectangle when operating in Simultaneous Multi-Frequency.*

 **15 kHz**  
*Displays the current selected single frequency in kHz: 5, 10, 15, 20\*, or 40\*.*

-  For all Detect Modes, Multi is the recommended Frequency setting.
-  Noise Cancel should be carried out whenever the Frequency setting is changed.

## Single Frequency Operation

Using a single frequency may have a slight advantage over multi-frequency in certain detecting situations.

For example; if you were searching only for larger high conductive targets located at great depth, using 5 kHz may give an advantage. Similarly, if you were hunting only for very fine gold jewellery at a shallow depth, then 20 kHz\* or 40 kHz\* may give better results in some detecting environments, such as at a beach on the dry sand.

In some noisy environments (e.g. high Electromagnetic Interference, where Noise Cancel is not fully effective), a single frequency may pick up less noise than Multi will, however maximum target sensitivity over a wide range of targets will be reduced.

The 4 kHz single frequency can be used to highlight very conductive targets, particularly large silver coins and other relics at depth. Users will note that this frequency may behave differently to the other single frequencies or Multi-IQ and may display greater noise characteristics in some soils.

## Frequencies and Detect Modes

The EQUINOX Detect Modes have different selections of Multi and single frequencies. Each Detect Mode is limited to the frequencies that will give the best performance for that mode. For example, Park and Field can operate across every available frequency setting, as good results can be achieved in any frequency.

Beach Mode however, can only perform successfully in typical beach conditions in Multi, therefore single frequencies are not available.

Similarly, Gold Mode\* is optimised for detecting low conductive gold nuggets that are more easily detected at higher frequencies. Therefore the lower single frequencies (4, kHz, 5 kHz, 10 kHz, and 15 kHz) are not available.

### EQUINOX 600

	Multi	4 kHz	5 kHz	10 kHz	15 kHz
Park	✓	✓	✓	✓	✓
Field	✓	✓	✓	✓	✓
Beach	✓	✗	✗	✗	✗

### EQUINOX 800

	Multi	4 kHz	5 kHz	10 kHz	15 kHz	20 kHz	40 kHz
Park	✓	✓	✓	✓	✓	✓	✓
Field	✓	✓	✓	✓	✓	✓	✓
Beach	✓	✗	✗	✗	✗	✗	✗
Gold*	✓	✗	✗	✗	✗	✓	✓

## Multi-IQ Technology

Multi-IQ is simultaneous multi-frequency detection and can be considered as combining the performance advantages of both FBS and VFLEX in a new fusion of technologies.

Multi-IQ achieves a high level of Target ID accuracy at depth much better than any single frequency detector can achieve, including switchable single frequency detectors that claim to be multi-frequency. When Minelab use the term 'multi-frequency' we mean 'simultaneous' – i.e. more than one frequency is transmitted, received and processed concurrently. This enables maximum target sensitivity across all target types and sizes, while minimising ground noise (especially in saltwater).

The diagram is intended to be a simplified representation of how different frequencies of operation are better suited to different target types; i.e. low frequencies (e.g. 5 kHz) are more responsive to high conductors (e.g. large silver targets) and high frequencies (e.g. 40 kHz\*) are more responsive to low conductors (e.g. small gold nuggets).

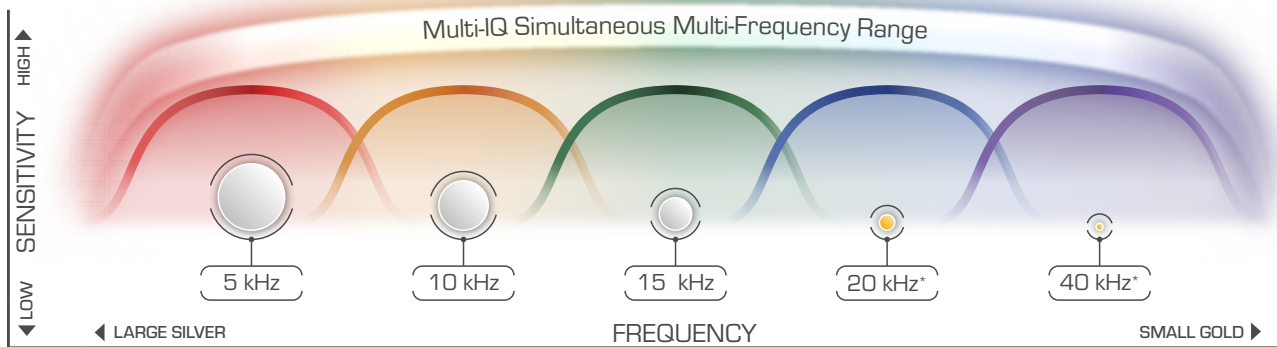

\* 20 kHz and 40 kHz are not available as single operating frequencies in EQUINOX 600. The Multi-IQ frequency range shown applies to both EQUINOX 600 and 800. This diagram is representative only. Actual sensitivity levels will depend upon target types and sizes, ground conditions and detector settings.

## Single Frequency Ranges

As well as operating with multi-frequency transmission, EQUINOX detectors also have single frequency options where all of the transmitter power is combined into one frequency for finding a specific type of target.

When selecting a detector with single frequency options, it is important to consider not only the number of frequencies but also the frequency range. A detector with more frequencies, but a smaller range will usually be less versatile than a detector with fewer frequencies and a wider range.

It is also important to recognise that some frequency bands may have limited value due to being widely used by communication agencies, making them unavailable for consumer products, such as metal detectors.

### 3F<sub>x3</sub>

EQUINOX 600 offers 4 single frequencies of 4 kHz\*, 5 kHz, 10 kHz, 15 kHz in addition to Multi, giving a 4 times (x4) range or ratio from 4 kHz to 15 kHz, hence the 4F<sub>x4</sub> technology designation.

### 5F<sub>x8</sub>

EQUINOX 800 offers 6 single frequencies of 4 kHz\*, 5 kHz, 10 kHz, 15 kHz, 20 kHz, and 40 kHz in addition to Multi, giving an expanded 11 times (x11) range or ratio from 4 kHz to 40 kHz.

\* Actual operating frequency in 4 kHz mode is 3.7 kHz



## Typical Target Examples

While both the Target ID numbers and Discrimination Scale give a good representation of a target's ferrous and non-ferrous properties, desired and undesired targets can fall anywhere within the overall range from -9 to 40. The table gives some common examples for good and bad targets, showing the Tone Regions where they will likely be detected.

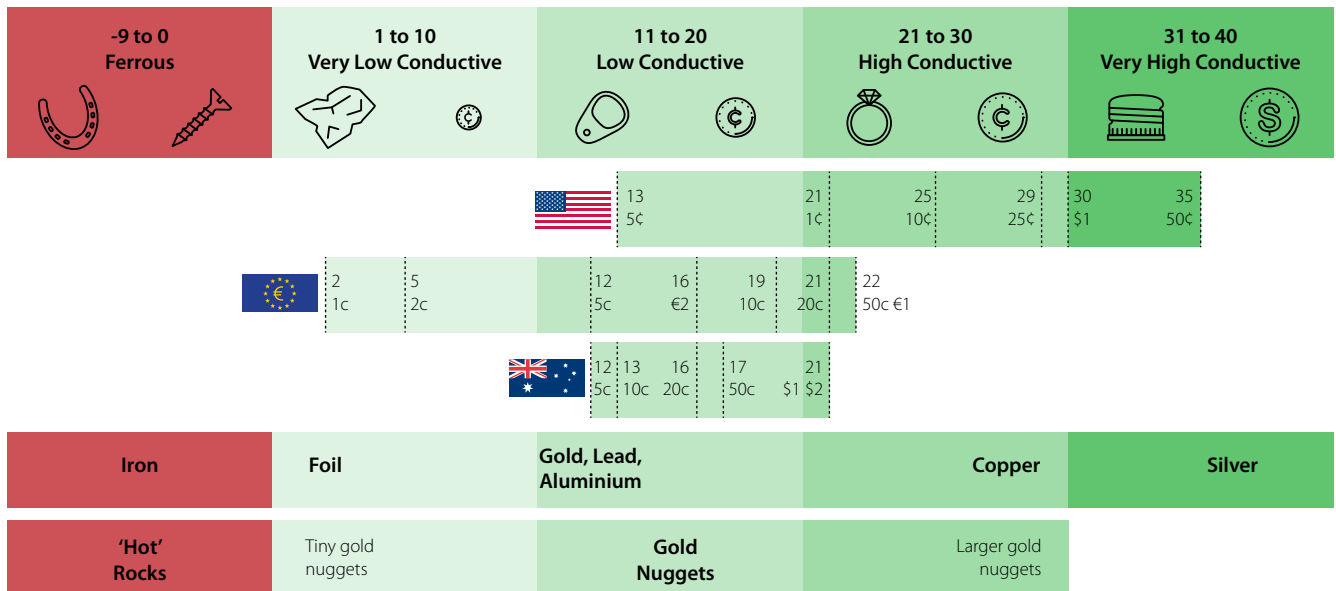

This chart is intended as a starting guide only. Target IDs may vary from the examples shown, depending upon the actual target metal composition, ground conditions and detector settings.

## Target ID Accuracy

Multi-IQ technology gives greater Target ID accuracy and increased detecting performance, especially in heavily mineralised ground. In benign ground, a single frequency may perform adequately, however depth and stable Target IDs will be limited by ground noise.

Multi-IQ simultaneous multi-frequency will achieve maximum depth with a very stable target signal. In mineralised ground, single frequencies will not be able to effectively separate the target signal from the ground signal, giving decreased results. Multi-IQ will still detect at depth, losing a minimal amount of Target ID accuracy.

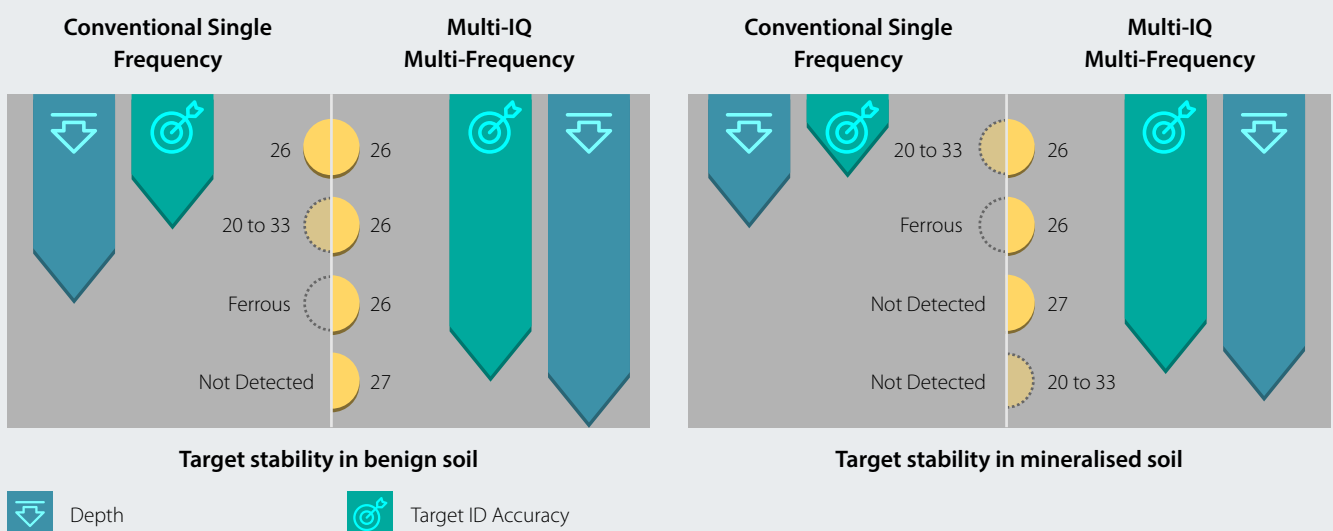

# Backlight

The EQUINOX LCD has a backlight for improved screen contrast in poor light conditions.



*EQUINOX 600 has 3 backlight level settings, Off, High, and Low.  
 EQUINOX 800 has 4 backlight level settings, Off, High, Medium, and Low.  
 The backlight is Off by default.*



*Backlight adjustment is global; all Detect Mode Search Profiles will be affected by changes to this setting.*



*Continual use of the backlight, especially at full brightness (High), will result in decreased battery runtime.*

## Turning the Backlight On

Press the Backlight button on the top left of the control panel.

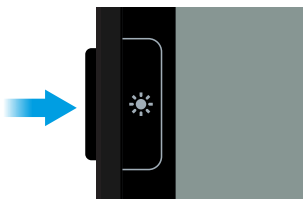

The backlight will illuminate at full brightness (High).



The Backlight icon will appear on the LCD when the backlight is on.

The backlight setting will be remembered after the detector is powered off. When the detector is turned on again, the backlight will automatically return to its last-used state.

## Adjusting the Backlight Brightness

1. Press the Backlight button on the left of the control panel. The Backlight will illuminate at full brightness (High).
2. Each press of the Backlight button will reduce the Backlight brightness by one level until the backlight is Off.



## User Profile\*

EQUINOX 800 features an additional User Profile side button that saves a copy of the current detector settings for future quick access.



User Profile stores the set values of all current local settings so that you can access them instantly later.

*The default settings for the User Profile are a copy of Park Mode Search Profile 1.*

### Save a User Profile

1. Select the Detect Mode you wish to use as a basis for your User Profile. Adjust the settings you wish to save.
2. Make sure you are in the Detect Screen, not the Settings Menu.
3. Press and hold the User Profile button on the right side of the control panel.



4. The User Profile icon on the LCD will begin to flash rapidly. It will then remain on and a rising confirmation tone will sound, indicating that the User Profile has been saved.

You can save over the User Profile at any time by repeating the above procedure.

### Activating the User Profile

Press the User Profile button at any time to re-activate the saved User Profile.

 The User Profile icon will appear on the LCD when the User Profile is active.

Any changes made to local settings when the User Profile is active will be saved automatically.

To exit from the User Profile, press either the User Profile button or the Detect Mode button. Settings will return to the last-used Detect Mode Search Profile and the User Profile icon will turn off.

# Sensitivity

EQUINOX is highly sensitive and has 25 Sensitivity levels. It is important to set the correct Sensitivity level for your detecting conditions.



Sensitivity adjusts the detector’s level of response to targets and the environment by controlling the amount of amplification applied to signals received by the detector (sometimes called Rx gain).

Targets are detected as distinct beeps that stop if the coil is held stationary. Interference or noise usually sounds like a crackling or popping, which generally continues when the coil is held stationary.

The Sensitivity setting has a range from 1 to 25 with a default setting of 20.



Sensitivity level adjustment is global; all Detect Mode Search Profiles will be affected by changes to this setting.

## Sensitivity Indicator

The Sensitivity Indicator on the EQUINOX LCD shows the approximate sensitivity level in increments of 5.

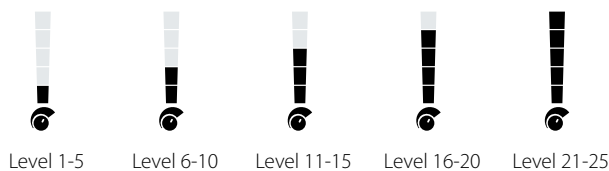

## Recommended Sensitivity Settings

Some experimentation with the Sensitivity level may be required for different detecting locations. For beginners, start with a low setting and increase it progressively.

Decreasing the Sensitivity of the EQUINOX may reduce false signals and interference. This will also improve differentiation between signals caused by metal targets and those of soil mineralisation.

The following recommended settings will help get you started:

New user	20
Park or field with no trash	22
Park or field with trash	20
Salt water beach	20
Gold Mode	15-25
Experienced user	22-25
Difficult ground or noisy conditions	15-18
Detecting test targets indoors	1-10

Tiny ferrous trash targets might be detected when the Sensitivity is set to a high level. The detector will also be affected by minerals in certain soils and signals from electrical appliances.

## Adjusting Sensitivity

Always choose the highest stable Sensitivity setting to ensure optimum performance.

You can only adjust the Sensitivity level from the Detect Screen. Before attempting to adjust Sensitivity, ensure that you are not in the Settings Menu or in Pinpoint.

1. Holding the coil stationary, use the Plus (+) button to increase the Sensitivity until false signals begin to occur.
2. Reduce the Sensitivity level by pressing the Minus (-) button, just enough that these false signals disappear.
3. The exact Sensitivity Level will be shown on the Target ID Display, and will disappear after 3 seconds of inactivity.

# Depth Gauge

The Depth Gauge indicates the approximate relative depth of a detected target.



The Depth Gauge is a guide only; fewer arrows indicate a shallower target, more arrows indicate a deeper target. The accuracy can vary depending on the target type and ground conditions.

*The Depth Gauge has 5 levels in increments of approximately 50 mm (2").*

When there is no detection, the Depth Gauge icon and arrows are off.

After a target is detected, the Depth Gauge will remain on the LCD for up to 5 seconds, or until the next target is detected.

Here is an example of the Depth Gauge reading and the approximate target depth for a US quarter detected in benign soil:

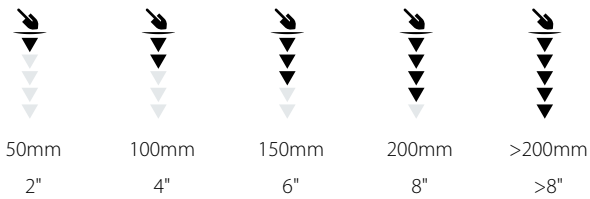

The depth gauge accuracy is reduced in highly mineralised soil.

# Pinpoint

Switching to Pinpoint when you find a target activates the target signal strength visualisation on the Discrimination Scale to help you accurately locate the buried target.



With Pinpoint enabled, the discrimination pattern is temporarily disabled so that EQUINOX will detect all metals. Pinpoint also switches off motion detection, so a target signal will be heard even if the coil is stationary.

Pinpoint progressively masks the Target response by reducing the Sensitivity with each sweep until only a very narrow target response remains. This helps identify the exact location of the target.

In Pinpoint, the detector's response indicates the strength of the target signal directly below the coil. The Pinpoint audio response is tone and volume modulated. The difference in tone and volume will help to locate the position and depth of the target.

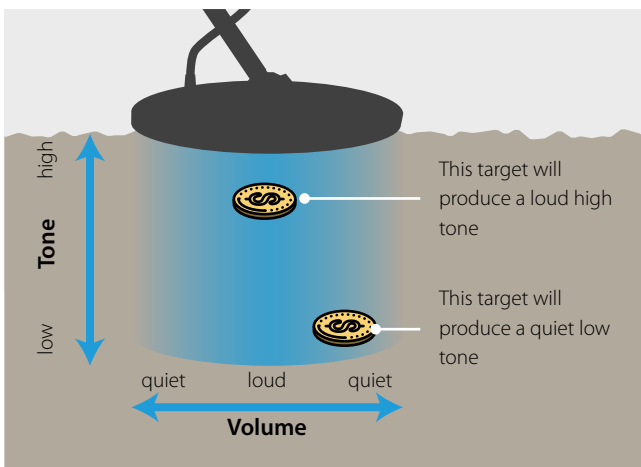

## Pinpointing a Target

1.  Press the Pinpoint/Detect button to enter Pinpoint. The Pinpoint icon will appear at the top centre of the LCD.

The Target ID of the detected target will remain on the Target ID Display and the depth indicator will show its approximate depth.

2. Sweep the coil slowly across the target location keeping the coil parallel to the ground.
3. Taking note of the response, locate the centre of the target by listening for the loudest signal and/or watching the Discrimination Scale on the LCD.
4. When all of the segments on the Discrimination Scale are on, the target will be below the centre of the coil.

 If you have difficulty Pinpointing the target, press Pinpoint/Detect again to take the detector out of Pinpoint and then return to Step 1.

The detector may become noisy if left in Pinpoint. If this occurs, return to normal detection then try Pinpoint again.

For more information on pinpointing technique, read 'Pinpointing Technique' on page 19.

## Pinpoint Visualisation

The Discrimination Scale on the LCD is used to represent the proximity of a target to the centre of the coil.

As a target nears the centre of the coil, the signal volume increases and becomes higher pitched, and the segments on the Discrimination Scale begin to appear from the outside of the scale.

When all of the segments on the Discrimination Scale are on, the target will be below the centre of the coil.

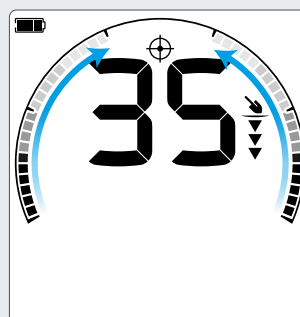

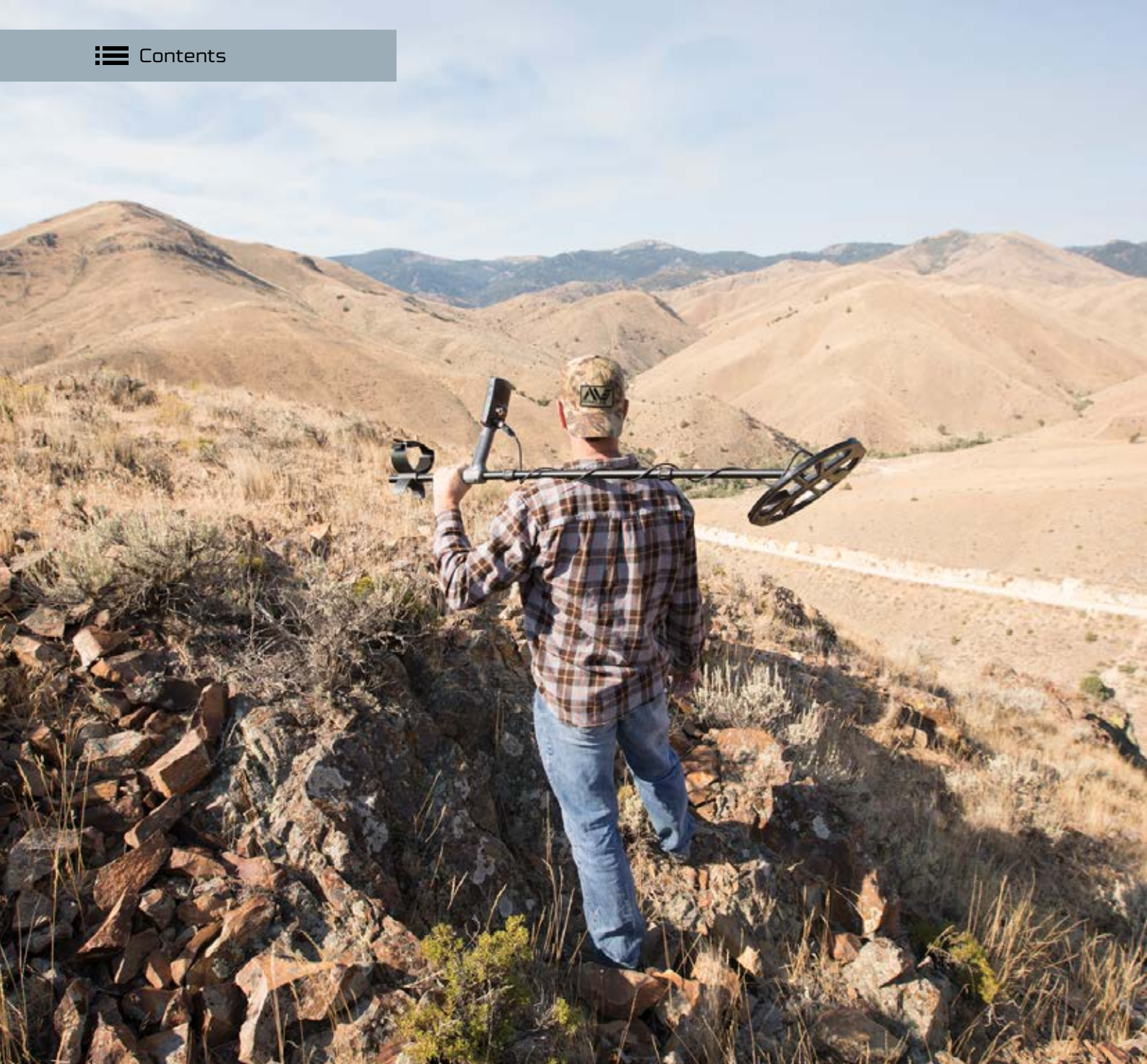

## Settings Menu

The Settings Menu contains many adjustable settings for improving performance. You can adjust Noise Cancel, Ground Balance, Volume, Target Tones and more...

# Settings Menu

The Settings Menu contains adjustable settings relating to the detector. You can change audio and other detecting settings via this menu.

## Settings



These top-level settings are the standard detecting adjustments that control the performance of your detector.

	Noise Cancel
	Ground Balance
	Volume Adjust
	Threshold Level
	Target Tone
	Accept/Reject
	Recovery Speed

## Settings Menu Navigation

The Settings Menu can be accessed from any screen by pressing the Settings button.

Each press of the Settings button will scroll to the next setting in the Settings Menu in a left-to-right direction. After the last Setting the detector returns to the Detect Screen. Press the Settings button again to begin scrolling from the left again.

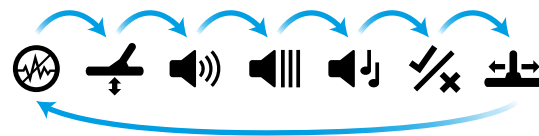

Pressing either the Detect Mode button or the Pinpoint/Detect button from the Settings Menu will return you to the Detect Screen.

The Settings Menu remembers the last accessed setting and will return you to that setting the next time the Settings button is pressed.

## Advanced Settings



Advanced Settings give additional control to customise detector audio and target signals. You have sound options to assist with hearing even more information about detected targets from the audio alone.

Advanced Settings are located in the Settings Menu, indicated by a line beneath the top-level Setting icon.

	Tone Volume
	Threshold Pitch*
	Tone Pitch
	Tone Break
	Iron Bias

*Threshold Pitch is not available in the EQUINOX 600.*

## Accessing Advanced Settings

1. Navigate to any top level Setting that has an Advanced Setting (e.g. Volume Adjust).
2. Press and hold the Settings button for 2 seconds. A line will appear beneath the icon indicating you can now adjust the Advanced Setting (e.g. Tone Volume). The screen will also change to show the advanced values you can now adjust.



3. Press and hold the Settings button for 2 seconds to return to the top level setting.

The Settings Menu remembers if an Advanced Setting was last accessed and will return you to that setting next time the Settings button is pressed.

# Noise Cancel

Noise Cancel reduces the effect of environmental electromagnetic noise from sources such as power lines, mobile phone towers, and other metal detectors.





Detectors may become noisy due to electrical interference from power lines, electrical equipment or other detectors operating close by. The detector interprets this interference as inconsistent, erratic detections.

The Noise Cancel setting allows you to change the noise cancel channel. This slightly shifts the detector transmit frequency to be less responsive to the source of the noise.

Noise Cancel affects both the audible detection noise level and pinpointing performance.

*The Noise Cancel setting has 19 channels with a range from -9 to 9 with a default setting of 0 for all Detect Mode Search Profiles.*

 *Noise Cancel adjustment is local; only the current Detect Mode Search Profile will be affected by changes to this setting.*

-  Auto is the recommended noise cancel method.
-  Noise Cancel should be carried out whenever the frequency setting is changed.

## Manual Noise Cancel\*

The Manual setting allows you to listen to each channel so you can manually select the one with the least interference.

This can be useful when detecting in close proximity to other detectors, or in locations with lots of electrical interference.

1. Hold the coil stationary and away from the ground.
2. Press the Settings button to navigate to the Noise Cancel setting in the Settings Menu.
3. Press the Minus (-) or Plus (+) buttons to change the channel. The channel is shown on the Target ID Display. Pause and listen to the interference being received. Keep the detector still during this process.
4. Once the channel with the least interference has been found, press either the Detect Mode button or the Pinpoint/Detect button to return to the Detect Screen.
5. The new Noise Cancel channel will be saved for the current Search Profile.

## Auto Noise Cancel

Auto Noise Cancel automatically scans and listens to every frequency channel and then selects the one with the least interference.

1. Hold the coil stationary and away from the ground.
2. Press the Settings button to navigate to the Noise Cancel setting in the Settings Menu.
3. Press the Accept/Reject button to initiate the Auto Noise Cancel process.

*Auto Noise Cancel can also be initiated on the EQUINOX 600 by pressing the Minus (-) or Plus (+) buttons.*

4. During the Auto Noise Cancel process the Discrimination Scale will show the progress of the operation, and there will be a series of ascending tones (approximately 8 seconds).

When this process is complete, the automatically selected channel will appear on the Target ID Display and three confirmation tones will sound.

5. Press either the Detect Mode button or the Pinpoint/Detect button to return to the Detect Screen.
6. The new Noise Cancel channel will be saved for the current Search Profile.

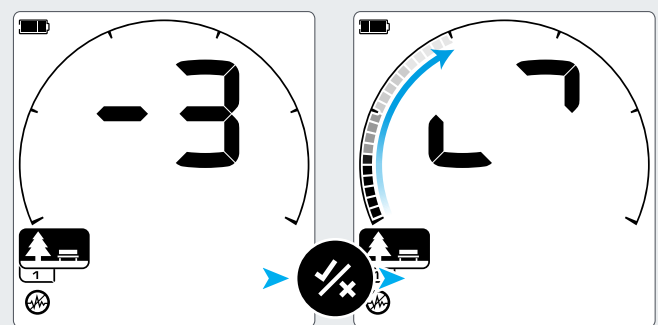

*The current Noise Cancel channel is shown on the Target ID Display. Press the Accept/Reject button to initiate Auto Noise Cancel.*

*The Target ID Display animates, and the Discrimination Scale indicates progress.*

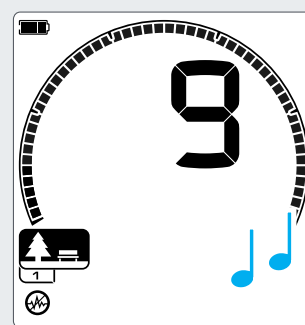

*Auto Noise Cancel complete. The automatically selected channel is shown on the Target ID Display (e.g. 9)*

 Auto Noise Cancel selects the 'quietest' signal channel based on several criteria. However, sometimes this selected channel may still have some audible noise present.

# Ground Balance

Ground Balance reduces noise caused by ground mineralisation, allowing good targets to be detected more clearly.



The Ground Balance setting calibrates the detector to the local ground in order to eliminate the false signals caused by mineralisation.

*The Ground Balance setting has a range from -9 to 99, with a default of 0 for all Park, Field, and Beach Mode search profiles.*

*Tracking Ground Balance is the recommended and default ground balance method for Gold Mode.*



*Ground Balance adjustment is local; only the current Detect Mode Search Profile will be affected by changes to this setting.*

## Manual Ground Balance

Ground Balance can be manually adjusted until the minimum amount of ground signal is heard.

1. Press the Settings button to navigate to the Ground Balance setting in the Settings Menu.
2. Raise and lower the coil repeatedly over a clear patch of soil that does not contain any targets.

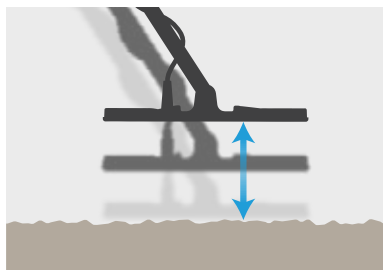

Listen to the audio response to interpret the result of the Ground Balance; a low tone indicates that you should increase the Ground Balance value and a high tone indicates that you should decrease it.

3. Press the Minus (-) and Plus (+) buttons to manually change the Ground Balance value until the minimum amount of ground signal is heard. The Manual Ground Balance value is shown on the Target ID Display.

## Auto Ground Balance

With Auto Ground Balance, the detector automatically determines the best Ground Balance setting after the balancing process is initiated by the operator.

Using Auto Ground Balance is the recommended Ground Balance Method.

1. Press the Settings button to navigate to the Ground Balance setting in the Settings Menu.
2. Press and hold the Accept/Reject button throughout the Auto Ground Balance process.



The Tracking Ground Balance icon on the LCD will begin to flash rapidly.

3. Raise and lower the coil repeatedly over a clear patch of soil that does not contain any targets. Observe the Ground Balance value updating dynamically on the Target ID Display, as the audio reduces in response to the ground.
4. The response will be stabilised when the value in the Target ID Display settles on a single value.
5. Release the Accept/Reject button.



The default Ground Balance setting of 0 is recommended for Park, Field and Beach Modes because these locations typically have less mineralisation than goldfields.

However, if the ground is generating many noise signals (and/or the Sensitivity level is set very low), then using Auto Ground Balance is recommended.

If the Auto Ground Balance process does not greatly reduce ground noise (due to highly mineralised ground or high salt levels), then repeat the Auto Ground Balance process by sweeping the coil from side-to-side, rather than the standard up-and-down motion.



## Tracking Ground Balance

When Tracking Ground Balance is active, the detector continuously adjusts the Ground Balance automatically during detecting. This ensures that Ground Balance is always set correctly.



Tracking Ground Balance is the default and recommended method for Gold Mode.

Tracking Ground Balance can also be useful when using Beach Mode 2 underwater at the beach (in salt water).



The Tracking Ground Balance icon will appear on the LCD when Tracking is active.

1. Press the Settings button to navigate to the Ground Balance setting in the Settings Menu.
2. Press the Accept/Reject button to activate Tracking Ground Balance. The Tracking icon will appear on the LCD.
3. When you return to the Detect Screen, Ground Balance will track automatically in the background, indicated by the Tracking icon. The icon will remain on until Tracking Ground Balance is turned off.

### Turning Off Tracking Ground Balance

1. Press the Settings button to navigate to the Ground Balance setting in the Settings Menu.
2. Press the Accept/Reject button to turn Tracking Ground Balance off. The Tracking icon will disappear, and Manual Ground Balance will be active.

## Volume Adjust

The Volume Adjust setting controls the level of all detector sounds to make them louder or more quiet.



Volume Adjust changes the loudness of all detector audio, including detection signals, the threshold tone, and confirmation tones.

*The Volume Adjust setting has a range from 0 (off) to 25 with a default setting of 20 for all Detect Mode Search Profiles.*

*When the volume level is set to 0, all audio is muted (off).*



*Volume Adjust changes are global; all Detect Mode Search Profiles will be affected by changes to this setting.*

### Adjusting the Volume

1. Use the Settings button to navigate to the Volume Adjust setting in the Settings Menu.
2. Use the Minus (–) or Plus (+) buttons to decrease or increase the volume to a comfortable level, making sure that loud signals (close or large targets) do not hurt your ears.

If you try to exceed maximum volume, there will be an invalid button press tone.

## Tone Volume (Advanced Setting)

This Advanced Setting allows you to set a different volume level for each Tone Region. This is a great feature when detecting in iron infested locations.



The volume of each tone associated with a Tone Region can be adjusted.

The Tone Volume setting has a range from 0 (off) to 25, with a default setting of 12 for ferrous tones, and 25 for non-ferrous tones.

 Tone Volume adjustment is local; only the current Detect Mode Search Profile will be affected by changes to this setting.

 The number of Tone Regions will vary depending on the set value of the Target Tone setting. This allows you to choose from 1, 2, 5 and 50 tones. Read 'Selecting the Number of Target Tones' on page 46 for more information.

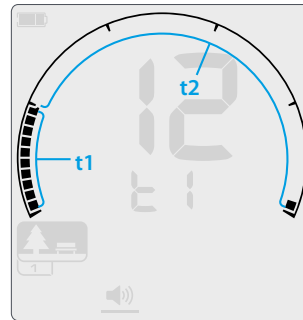

Tone Volume adjustment screen for Tone Region 1 (t1), with a Target Tone setting of 2; The Discrimination Scale is divided into 2 regions.

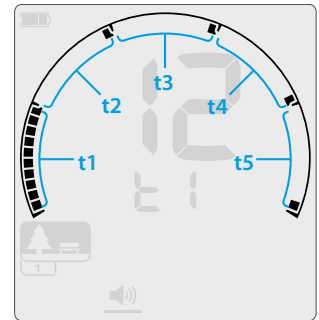

Tone Volume adjustment screen for Tone Region 1 (t1), with a Target Tone setting of 5; The Discrimination Scale is divided into 5 regions.

### Adjusting Tone Volume

1. Use the Settings button to navigate to the Volume Adjust setting in the Settings Menu.
2. Press and hold the Settings button for 2 seconds. A line will appear beneath the icon indicating that the Tone Volume Advanced Setting has been selected.
3. The Frequency Display will indicate the Tone Region that is currently selected (e.g. t1) and the Tone Region segments on the Discrimination Scale will be on. Press the Minus (-) or Plus (+) buttons to adjust the volume of the selected Tone Region.
4. Press the Accept/Reject button again to advance to the next Tone Region (i.e. t2). 1, 2, or 5 Tone Regions can be adjusted depending on the selected Target Tone setting.

*Only the ferrous tone (t1) can be adjusted on the EQUINOX 600.*

5. Repeat until all Tone Regions have been adjusted.
6. A long press of the Settings button will return you to the Volume Adjust setting.



In trashy or iron infested locations, set the Tone Volume of the ferrous Tone Region to zero and increase the volume of the Tone Regions where your preferred targets will appear.

You will not hear undesired ferrous targets and highly desired high conductive targets signals will be emphasised, by giving the loudest target response.

Other non-ferrous targets that are not within the preferred target Tone Region will be still be heard, but will be quieter.

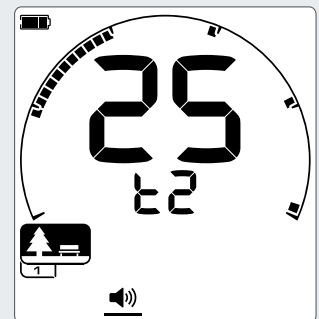

When adjusting the Tone Volume setting, press the Accept/Reject button to advance to the next Tone Region. (5 tones shown)

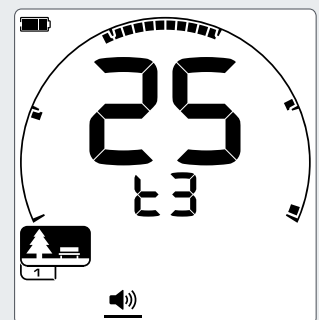

# Threshold Level

Threshold is the constant background sound that can be produced by the detector.



Threshold is a useful setting for distinguishing between desirable and undesirable targets, as well as hearing faint gold nugget signal responses.

The Threshold Level setting has a range from 0 to 25 with a default setting of 0 (off) for Park, Field, and Beach Modes, and a default setting of 12 for Gold Mode\*.

 Threshold Level changes are semi-global; Park, Field, and Beach Mode Search Profiles will be affected by changes to this setting when in any of these modes.

Gold Mode\* Threshold Level is controlled separately to the other modes.

## Adjusting the Threshold Level

The Threshold Level Setting for all Detect Modes is adjusted in the same way.

1. Use the Settings button to navigate to the Threshold Level setting in the Settings Menu.
2. Press the Minus (-) or Plus (+) buttons to adjust the Threshold Level. Adjustment takes effect immediately, so listen to the audio to select your preferred level.

With the EQUINOX 800, the pitch of the Threshold tone can be set higher or lower via the Threshold Pitch Advanced Setting (page 45).

## Threshold Blanking

When a rejected target is detected, the Threshold tone 'blanks' (becomes silent) to indicate that a rejected target is underneath the coil.

If the Threshold is set to 0, you will not hear the blanking of the rejected targets.

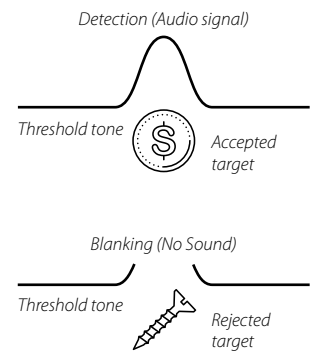

## Park, Field, and Beach Threshold

Park, Field, and Beach Modes use a simplified type of threshold tone, i.e. a 'reference' threshold. It is a continuous background tone that will blank when a rejected target is detected. Without a reference threshold, a rejected target detection would be silent, and you would not be made aware of the target's existence.

For typical treasure detecting locations where there is often a large amount of trash in the ground, constant audio blanking may be disruptive.

Minelab recommends using a Threshold Level setting of 0 (off) for Park, Field and Beach applications, unless you want to hear audio blanking.

## Gold Threshold

The Threshold for Gold Mode is a 'true' threshold tone that can be adjusted to improve the audibility of faint signals from small gold nuggets. Unlike a 'reference' Threshold, 'true' Threshold allows gold nugget signals to be emphasised in typically mineralised 'noisy' goldfield soils. Greater control of the target audio response may be achieved by adjusting the Threshold and Volume settings together.

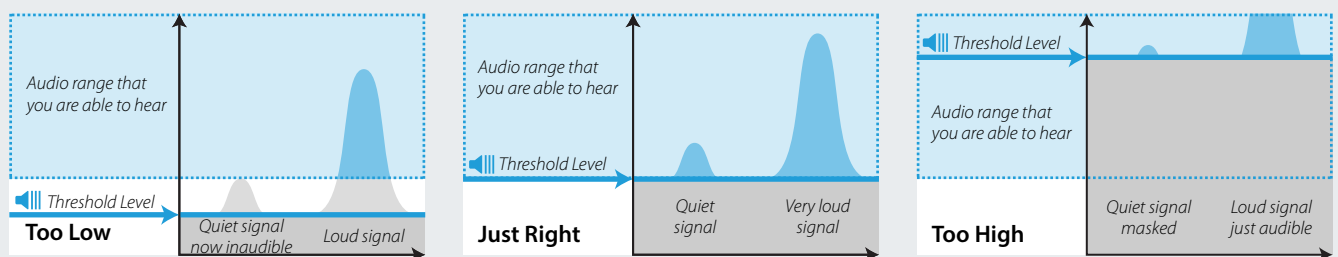

If the Threshold Level is too low, the slight variation caused by a small or deep target may not be sufficient to hear. Adjusting the level to below an audible level will ensure silent operation but could mask the audio response from small or deep targets.

Adjust the Threshold Level to a faint audible hum. This will emphasise variations in signal response which may indicate the presence of a target. If the soil conditions change, the Threshold Level may need further adjustment.

If the Threshold Level is too high, faint targets will be harder to hear above the Threshold hum.

## Threshold Pitch\* (Advanced Setting)

This EQUINOX 800 Advanced Setting allows you to set the threshold tone to be higher or lower pitched. Set the level to the most comfortable pitch for your hearing.



Threshold Pitch allows you to adjust the audio pitch of the Threshold tone. Hearing will vary between individuals, so adjust the Threshold Pitch to a level that is comfortable for your hearing.



*The Threshold Pitch setting has a range from 1 to 25 with a default setting of 4 for Park, Field, and Beach Modes, and a default of 11 for Gold Mode.*

*Threshold Pitch changes are semi-global; Park, Field, and Beach Mode Search Profiles will be affected by changes to this Advanced Setting when in any of these modes. Gold Mode\* Threshold Pitch is adjusted separately to the other modes.*

### Adjusting the Threshold Pitch

1. Use the Settings button to navigate to Threshold Level in the Settings Menu.
2. Press and hold the Settings button for 2 seconds. A line will appear beneath the Threshold Level icon indicating you have selected the Threshold Pitch setting, and 'Pt' will appear on the Frequency Display.
3. Press Plus (+) to set the threshold tone to a higher pitch. Press Minus (-) to set threshold tone to a lower pitch. Any adjustments are automatically saved.
4. A long press of the Settings button will return you to the Threshold Level setting.

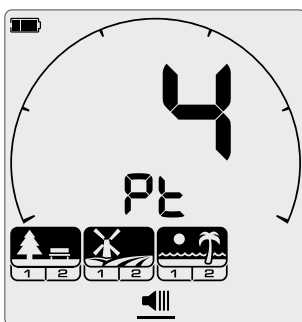

*Threshold Pitch adjustment screen - Park, Field, and Beach Modes.*

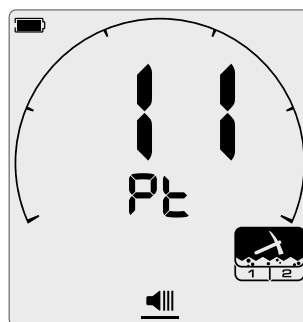

*Threshold Pitch adjustment screen - Gold Mode.*

# Target Tone

The Target Tone Setting controls the number of different tones you will hear for different types of targets and the number of adjustable Tone Regions for Advanced Settings.



Target Tone allows you to divide the Target ID range into separate Tone Regions. Therefore, you can hear more or less target information.

The Target Tone setting has the options of 1, 2, 5 and 50.

 Target Tone adjustment is local; only the current Detect Mode Search Profile will be affected by changes to this setting.

Gold Mode\* has a Target Tone setting of 1 only, and cannot be changed.

## Selecting the Number of Target Tones

1. Use the Settings button to navigate to Target Tone in the Settings Menu.
2. Use the Minus (-) and Plus (+) buttons to select the number of audio tones of 1, 2, 5 or 50.

### Default Target Tone settings:

Search Profile	Default Setting
Park 1	5
Park 2	50
Field 1	2
Field 2	50
Beach 1	5
Beach 2	5
Gold 1*	1
Gold 2*	1

Examples showing the default Tone Region end positions for Park Mode.

### 1 Tone: There is 1 tone region (t1)

All detection tones have the same pitch.

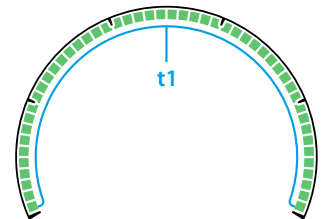

### 2 Tones: The Discrimination Scale is divided into 2 Tone Regions.

By default this is at the ferrous/non-ferrous division, however this point can be adjusted. Ferrous tones signals have one pitch and non-ferrous signal have a different pitch.

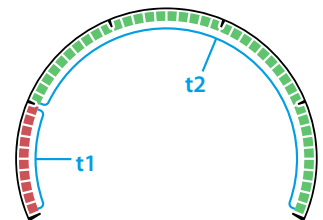

### 5 Tones: The Discrimination Scale is divided into 5 Tone Regions.

By default this is at (or near) each division guide on the Discrimination Scale. Each of the Tone Regions has a different pitch.

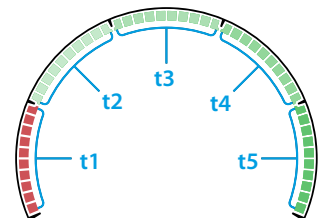

### 50 Tones: The Discrimination Scale is divided into 2 Tone Regions.

By default this is at the ferrous/non-ferrous division, however this point can be adjusted. The Ferrous Tone Region has a narrow range of lower pitched tones. The non-ferrous Tone Region has a wider range of higher pitched tones.

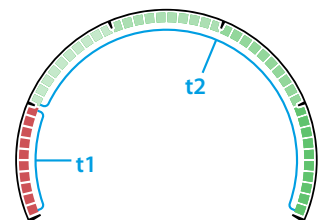

## Target Tone Dependencies

When the Target Tone setting is changed, the options in the Advanced Settings of Tone Volume, Tone Pitch, and Tone Break also change.

These Tone Regions can then have their Pitch, Volume, and Tone Region end positions controlled individually. The current Pitch, Volume and Tone Region settings are saved independently for each Target Tone setting.

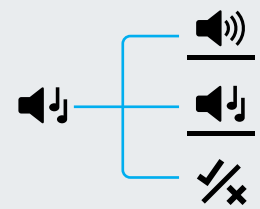

## Tone Pitch (Advanced Setting)

This Advanced Setting allows you to adjust the pitch of target responses for specific types of targets. This makes it easier to hear your preferred targets.



The pitch of each Tone Region can be adjusted. This may be useful to help differentiate between common targets with similar Target IDs.

The Tone Pitch setting has a range from 1 to 25.

 Tone Pitch adjustment is local; only the current Detect Mode Search Profile will be affected by changes to this Advanced Setting.

Tone Pitch is not available in Gold Mode\*.

EQUINOX 600 allows only the first Tone Pitch to be adjusted.  
EQUINOX 800 allows all Tone Pitches to be adjusted.

### Tone Pitch Default Settings

Depending on the set number of Target Tones, there are different default Tone Pitch settings for each Tone Region. These can be adjusted to different values at any time.

Number of Tones	Default Setting
1	11
2	1, 20
5	1, 6, 12, 18, 25
50	1, 20

### Adjusting Tone Pitch: 1, 2, or 5 Tones

1. Use the Settings button to navigate to Target Tone in the Settings Menu.
2. Press and hold the Settings button for 2 seconds. A line will appear beneath the Target Tone icon indicating you have selected the Tone Pitch setting.
3. Press Plus (+) to set the Target Tone to a higher pitch. Press Minus (-) to set the Target Tone to a lower pitch.
4. To advance to adjusting the pitch of the next Tone Region (i.e. t2), press the Accept/Reject button.

*If the Target Tone setting is set to a value of 1, there will only be 1 Tone Region (t1).*

5. A long press of the Settings button will return you to the Target Tone setting.

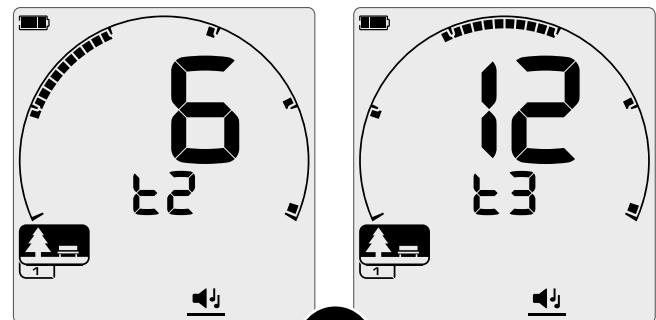

When adjusting the Tone Pitch Advanced Setting, press the Accept/Reject button to advance to the next Tone Region.

## Adjusting Tone Pitch: 50 Tones

When a Target Tone setting of 50 is selected for a Search Profile, the Tone Pitch Advanced Setting behaves differently.

To provide greater audio separation between ferrous and non-ferrous targets, a deliberate gap can be set between the highest possible pitch of the ferrous tones, and the lowest possible pitch of the non-ferrous tones.

Therefore a non-ferrous target with a Target ID very close to the ferrous range will sound much higher pitched and therefore easy to distinguish as non-ferrous from the audio signal alone.

Adjust the Tone Pitch of 50 tones in the same way as adjusting the Tone Pitch of 1, 2 and 5 tones (page 47).

The non-ferrous setting cannot be a higher number than the ferrous setting.

The example below shows how 'masking' sections of the full pitch range makes it easier to hear a clear difference between ferrous and non-ferrous targets.

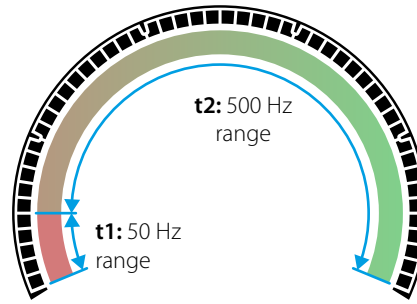

The Tone Pitch setting of 1, 24 represented on the Discrimination Scale when the Tone Break setting is -5.

The 500 Hz non-ferrous tone range is spread across Tone Region 2 (t2), and the 50 Hz ferrous tone range is spread across Tone Region 1 (t1).

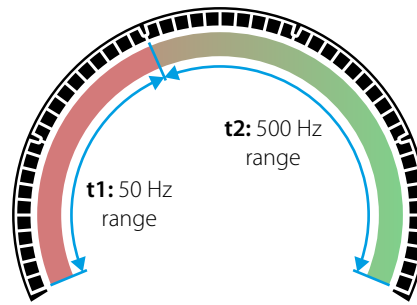

This shows the same Tone pitch setting, but a higher Tone Break setting of 10.

This means that the 500 Hz high tones becomes compressed into fewer Target IDs, and the 50 Hz low tones are stretched across more Target IDs.

### Default Tone Pitch Gap (1, 20)

Ferrous targets will be very low pitched. Non-ferrous targets will sound distinctly higher pitched than a ferrous target with a similar Target ID.

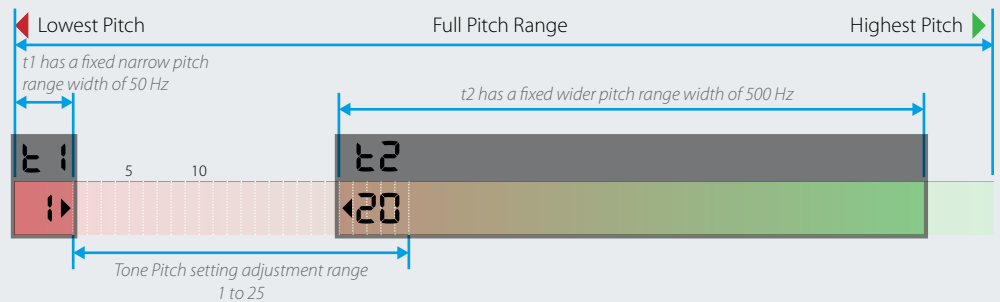

### Maximum Tone Pitch Gap (1, 25)

A greater difference in Pitch between ferrous and non-ferrous targets gives very easy differentiation.

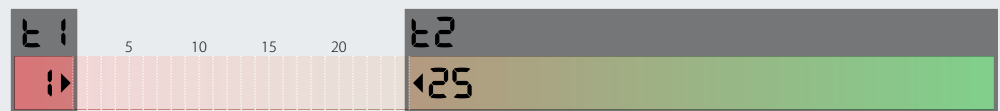

### Small Tone Pitch Gap (11, 12)

No clear difference in pitch between ferrous and non-ferrous targets. They may be indistinguishable from audio alone.

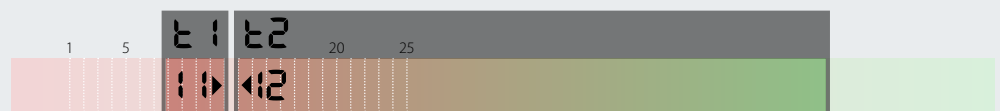



# Accept/Reject

You can create your own discrimination patterns to detect or ignore specific target types, so you can dig more treasure and less trash.



Targets are represented by both a Target ID number and an individual segment on the Discrimination Scale (page 30).

Target ID segments can be turned on or off to either detect (accept) or ignore (reject) targets. All Target IDs that are on will be accepted and all Target IDs that are off will be rejected.

The combinations of accepted and rejected segments are referred to as discrimination patterns.

The Discrimination Scale has a range from -9 to 40.

 Discrimination patterns are local, only the active Detect Mode Search Profile will be affected by changes to the pattern.

## Creating a Discrimination Pattern

1. Use the Settings button to navigate to Accept/Reject in the Settings Menu.
2. Navigate to the Target ID you wish to change, using the Minus (-) and Plus (+) buttons. The Plus button will move one segment in a clockwise direction with each press. The Minus button will move one segment anti-clockwise with each press.  
  
The current selected Target ID will flash slowly, and the corresponding Target ID number will appear on the Target ID Display.
3.  Press the Accept/Reject button to turn the Target ID on or off. A Target ID will be detected if the Target ID segment is on.
4. Continue to navigate around the Discrimination Scale, turning Target IDs on or off with the Accept/Reject button until you have created your discrimination pattern.

## Accepting/Rejecting Detected Targets

A target can be rejected upon detection if the corresponding Target ID is currently turned on in the discrimination pattern.

If a Target ID is currently accepted and a detection occurs, an audio response will be heard, the Target ID segment will flash, and the Target ID number will appear on the Target ID Display.

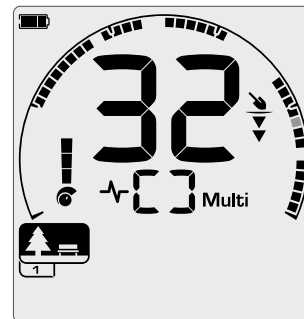

An accepted non-ferrous target with a Target ID of 32 is detected. Segment 32 on the Discrimination Scale will flash.



To reject the detected target, press the Accept/Reject button.

Targets with that Target ID will now be rejected, and will not be heard.

The last rejected target can be instantly re-accepted by pressing the Accept/Reject button again, as long as no other detection occurs before doing so.

Accepting a rejected Target ID is not possible directly from the Detect Screen. Rejected Target IDs must be re-accepted by adjusting the discrimination pattern via the Accept/Reject Setting in the Settings Menu.

## All Metal

 Turn All Metal on by pressing the All Metal button on the control panel.

This disables the current discrimination pattern so that all metal objects will be detected.

Press the All Metal button again to turn the discrimination pattern back on.

All Metal is off by default each time the detector is turned on.

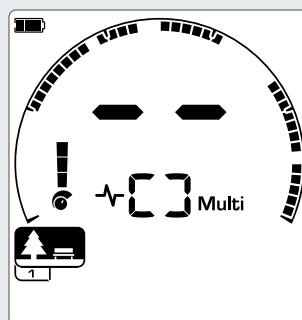

Discrimination pattern active.

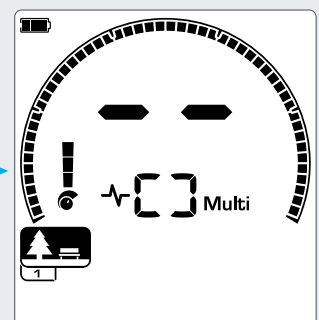

All Metal active - All Discrimination Scale segments are on.

## Tone Break (Advanced Setting)

This Advanced Setting allows you to move the end position of each Tone Region.



Very low conductive non-ferrous targets in varying ground conditions may be detected within the ferrous Target ID range.

The Tone Break setting allows you to move the point at which ferrous tones occur. For example, you may want ferrous tones to occur for any target with a Target ID from -9 to 2. Using the Tone Break setting, you can move the ferrous tone end position up to 2. This moves some non-ferrous targets into the ferrous range, however you will now also ignore many of the 'bad' ferrous targets.

You can also adjust the end positions of other Tone Regions to gain greater distinction between targets of varying conductivity levels.

*Target IDs -9 to 0 are set as ferrous by default for Park and Beach Modes, and -9 to 2 for are set as ferrous by default for Field Mode.*

 *Tone Break adjustment is local; only the current Detect Mode Search Profile will be affected by changes to this Advanced Setting.*

*Tone Break is not available in Gold Mode\*, or when the Target Tone setting is 1.*

### Adjusting Tone Break

EQUINOX 600 allows only the ferrous Tone Break position (t1) to be adjusted. EQUINOX 800 allows 4 Tone Break positions (t1, t2, t3, t4) to be adjusted.

1. Use the Settings button to navigate to Accept/Reject in the Settings Menu.
2. Press and hold the Settings button for 2 seconds. A line will appear beneath the Accept/Reject icon, indicating that you have selected the Tone Break setting.

The Tone Region currently selected will be displayed on the Frequency Display (e.g. t1). The Target ID Display will show the current value of the Tone Region end point, (e.g. 0), and the corresponding Target ID segment will flash slowly.

3. Navigate to the Target ID segment you want to use as the end position; Press the Plus (+) button to move the end position one segment in a clockwise direction. Press the Minus (-) button to move it one segment anti-clockwise.
4. To advance to adjusting the next Tone Region end position (i.e. t2), press the Accept/Reject button.

Note that the last Tone Region end position cannot be adjusted because the end position is always 40.

5. A long press of the Settings button will return you to the top level setting.

### Tone Break Default Settings

Depending on the number of Target Tones selected, each mode has different presets. These can be adjusted.

Number of Tones	Park   Beach	Field
2	0	2
5	0, 10, 20, 30	2, 10, 20, 30
50	0 (1 adjustment position)	2 (1 adjustment position)

Examples of the Tone Break adjustment screen when the Target Tone setting is 5.

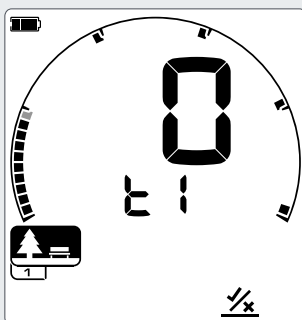

*Tone Break adjustment screen showing the default Tone Break end point for t1: 0.*

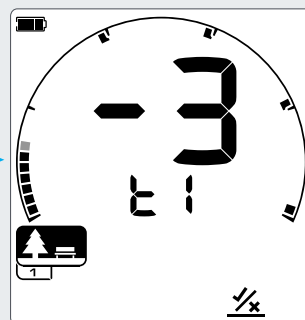
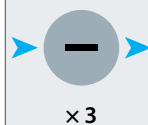

*Tone Break end point for t1 adjusted to -3.*

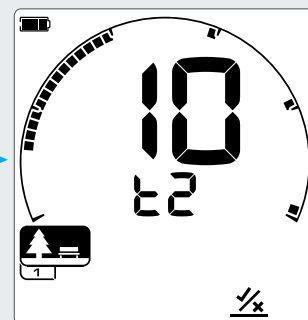
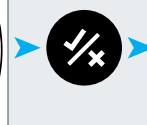

*Press Accept/Reject to advance to the next Tone Break, t2.*

# Recovery Speed

The Recovery Speed setting alters how quickly the detector responds from detecting one target to detecting another target.



By increasing the Recovery Speed, the detector is able to better differentiate between multiple targets that are close together. This assists in high-trash areas with finding smaller desired targets amongst larger iron trash.

*EQUINOX 600 has 3 Target Recovery Speeds, and EQUINOX 800 has 8 recovery speeds.*

 Recovery Speed adjustment is local; only the current Detect Mode Search Profile will be affected by changes to this setting.

While using a higher target Recovery Speed may increase the ability of the detector to find difficult targets, it also results in reduced Target ID accuracy and less detection depth.

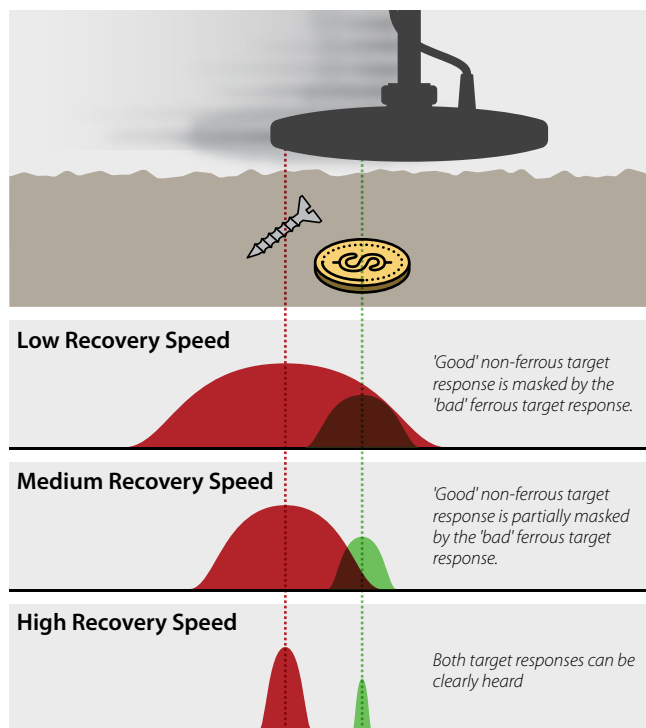

## Adjusting Recovery Speed

When adjusting the Recovery Speed for the first time, lay out some overlapping targets to test how the detector responds with different Recovery Speed settings.

1. Use the Settings button to navigate to Recovery Speed in the Settings Menu.
2. Press the Minus (-) and Plus (+) buttons to decrease or increase the Recovery Speed. Adjustments are automatically saved.

### EQUINOX 600/800 Equivalent Recovery Speeds

The following shows the equivalent recovery speeds between the two models. EQUINOX 600 offers fewer adjustment increments and a slower maximum Recovery Speed than the 800 model.

EQUINOX 800	1	2	3	4	5	6	7	8
EQUINOX 600	1	2	3					

### Default Recovery Speed Settings:

Detect Mode	EQUINOX 600	EQUINOX 800
Park 1	3	5
Park 2	3	6
Field 1	3	6
Field 2	3	7
Beach 1	3	6
Beach 2	3	6
Gold 1*	—	6
Gold 2*	—	4

## Swing Rate

A good general swing rate is around 2-3 seconds from right-to-left-to-right. A higher Recovery Speed generally allows for a faster swing rate with less likelihood of missing targets.

A higher Recovery Speed, for the same swing rate, will help to reject ground noise, but also decrease detection depth. A lower Recovery Speed, for the same swing rate, will increase detection depth, but may increase noise.

If you are experiencing high levels of ground noise at the beach, or when detecting underwater, try increasing the Recovery Speed to reduce the noise. It is also possible to vary both swing rate and Recovery Speed to help minimise ground noise.

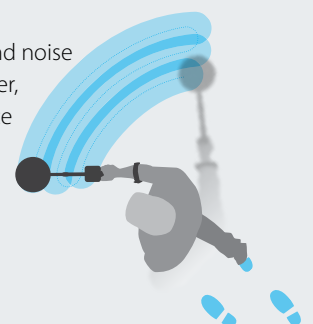

## Iron Bias (Advanced Setting)

The Iron Bias setting adjusts the likelihood of the detector to identify a target as iron if it presents both ferrous and non-ferrous signals.

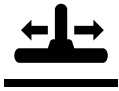

All ferrous targets produce a combination of ferrous and non-ferrous responses. Large ferrous targets can present an even stronger non-ferrous response. A ferrous target adjacent to a non-ferrous target can produce a similar response.

The Iron Bias FE Setting provides some control over the Target ID response. A lower Iron Bias setting will allow the natural response to dominate which means that the target is more likely to be classified as a non-ferrous target. A higher setting will increase the likelihood that the target is classified as iron.

The Iron Bias F2 Setting provides tone and Target ID response adjustment for a wider range of ferrous targets, including some types of crown cap bottle tops that Iron Bias FE is less effective for. Iron Bias F2 is best used in All Metal Mode, with iron tones audible.

The Iron Bias FE and F2 settings have a range from 0 to 9. Iron Bias is only available when the operating frequency is Multi.

 Iron Bias adjustment is local; only the current Detect Mode Search Profile will be affected by changes to this Advanced Setting.

In environments with dense iron trash, a higher Iron Bias is recommended in order to mask them. In areas where you do not want to miss any non-ferrous targets amongst iron trash, a lower setting is recommended. This will cause more ferrous targets to be detected and mis-identified as desirable non-ferrous targets.

The Iron Bias FE and Iron Bias F2 settings profiles are independent. When Iron Bias FE is selected, the Iron Bias F2 setting has no effect, and vice versa.

### EQUINOX 600/800 Iron Bias Setting Equivalents

The following shows the equivalent Iron Bias settings between the two models. EQUINOX 600 provides the same maximum Iron Bias as the 800 model, but offers fewer adjustment increments.

EQUINOX 800	0	1	2	3	4	5	6	7	8	9
EQUINOX 600	0		1		2		3			

## Adjusting Iron Bias

1. Use the Settings button to navigate to Recovery Speed in the Settings Menu.
2. Press and hold the Settings button for 2 seconds. A line will appear beneath the Recovery Speed icon, indicating you have selected the Iron Bias setting, and either 'FE' or 'F2' will appear on the Frequency Display.
3. Press the Accept/Reject button to toggle between Iron Bias FE and Iron Bias F2.
4. Press the Minus (-) and Plus (+) buttons to decrease or increase the Iron Bias FE or F2. Adjustments are automatically saved.
5. A long press of the Settings button will return you to the Recovery Speed setting.

Note: the last selected Iron Bias mode (FE or F2) when exiting settings will be the active Iron Bias mode.

### Default Iron Bias Settings:

Detect Mode	EQUINOX 600		EQUINOX 800	
	FE*	F2	FE*	F2
Park 1	2	2	6	6
Park 2	0	2	0	6
Field 1	0	2	0	6
Field 2	0	2	0	6
Beach 1	2	2	6	6
Beach 2	2	2	6	6
Gold 1*	—	—	6	6
Gold 2*	—	—	6	6

\* Iron Bias FE Setting Profile is the factory default Iron Bias profile for all Detect Modes.

Examples of the Iron Bias FE and F2 adjustment screens.

Iron Bias F2 is available from software update version 2.1 or later. Visit [www.minelab.com](http://www.minelab.com) for up-to-date EQUINOX software and installation instructions.

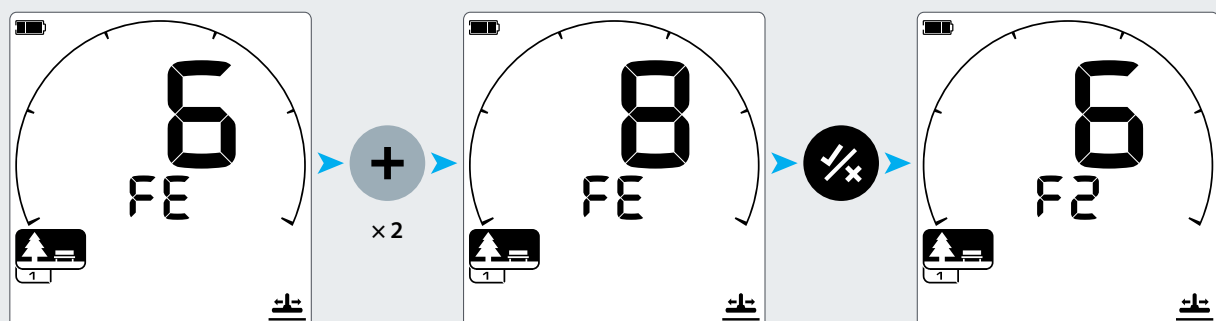

Iron Bias FE adjustment screen.

Iron Bias FE adjusted to 8.

Press Accept/Reject to advance to adjusting the Iron Bias F2 setting.



## Detector Audio

EQUINOX Series detectors have many audio options to suit any preference and detecting situation.

Wireless headphones can be used with the EQUINOX Series. EQUINOX is compatible with Bluetooth® aptX™ Low Latency and Minelab's super-fast Wi-Stream audio technology.

## Audio Options

EQUINOX has both wired and wireless audio options to choose from.

There is a range of audio accessories available. EQUINOX is also compatible with most readily available headphones.

The diagram shows the back of the EQUINOX detector with callouts to various audio features:

- Wireless Audio:**
  - ML 80 and other Wireless Bluetooth® aptX™ Low Latency headphones
  - WM 08 Wireless Audio Module 3.5 mm (1/8-inch) headphones required
  - Other Bluetooth® headphones
- Speaker:** A circular speaker grille on the top half of the device.
- Wired Headphones:**
  - 3.5 mm (1/8-inch) headphones
  - 6.35 mm (1/4-inch) headphones (Adaptor required)
  - Waterproof headphones Minelab 3.5 mm (1/8-inch)

## Wireless Audio Latency

Each EQUINOX compatible wireless technology has a slightly different latency, or delay. When metal detecting, the lowest latency is best.

When the coil is moving across the ground, any delay (latency) of the audio signal means that the coil will have moved past the target that produced that audio. Low latency (less audio delay) causes targets to be detected closer to where they really lie in the ground. This is very evident when swinging a coil left and right across a target. A higher latency will mean that the target is perceived to be in two locations either side of the actual location. A lower latency will minimise this effect.

**!** Wireless Audio can not be used if the control unit is submerged. EQUINOX waterproof wired headphones are required for underwater detecting. Submerging the coil only will not affect wireless audio operation.

### Wi-Stream Technology

Wi-Stream uses efficient low-power digital audio transmission to achieve the non-perceivable audio time lag of 17 ms between EQUINOX and the WM 08 Wireless Module.

For the fastest possible wireless audio, use the WM 08 Wireless Audio Module\*.



### Qualcomm® aptX™ Low Latency Technology

aptX™ Low Latency technology is faster than standard Bluetooth, with a delay of 40 ms, giving a faster detection response.

Minelab ML 80\* headphones use aptX™ Low Latency technology, and will deliver faster audio than standard Bluetooth® headphones.



### Bluetooth® Technology

Any standard Bluetooth® headphones or earbuds can be used with an EQUINOX Series detector.

However, Bluetooth® technology has a high audio latency of 100 ms.

This can make it difficult to visualise the exact position of a buried target if you are detecting with a fast swing rate.



## WM 08 Wireless Audio Module





The WM 08 receives wireless audio using advanced Wi-Stream technology to achieve ultra-fast clear sound with no perceivable time delay.

The WM 08 has a 3.5 mm (1/8-inch) headphone socket. It can be attached to your clothing using the wire clip. The WM 08 must be paired to the EQUINOX before it can receive wireless audio.



The WM 08 does not have a speaker so must be used with headphones. To use with the ML 80 Wireless Headphones, connect the auxiliary cable.

The WM 08 headphone socket is compatible with the EQUINOX waterproof headphones, available as an accessory. Note that the WM 08 itself is water resistant only and is not designed for use underwater.

-  Attach the WM 08 to the same side of your body as the detector to ensure the most reliable wireless signal.
-  When WM 08 is not in use, ensure that the plastic dust-cap is screwed firmly into the headphone socket.
-  EQUINOX is not compatible with Minelab WM 10 and WM 12 wireless audio modules.
-  Avoid having the WM 08 in close proximity to other wireless electronic devices e.g. a smartphone

### Pairing the WM 08

Pairing the WM 08 is only required at first time use, or when the WM 08 has been paired to a different detector. EQUINOX will automatically connect to the paired WM 08 for all future uses.

1. Press the WM 08 Power button for 2 seconds. The connection LED will slowly flash blue.
2. Press the Pairing button on the WM 08 until the blue LED starts flashing rapidly.
3. Press the Wireless button on the side of the EQUINOX control panel for 2 seconds until the LCD wireless icon starts to flash rapidly.

*For first-time use of the EQUINOX, or following a factory reset, a short press of the Wireless button will immediately start the pairing sequence.*

4. The blue LED on the WM 08, and the Wireless and Headphones icons on the EQUINOX LCD will stop flashing and remain on when the WM 08 has successfully paired.

If pairing is not successful within 15 seconds of initiating the pairing sequence, return to step 1.

### Unpairing a WM 08













WM 08 audio modules can only be unpaired by pairing them to another EQUINOX detector.

### Pairing Additional WM 08 Modules

Up to 4 WM 08 audio modules can be in use simultaneously. This is a useful feature for group training sessions. To pair additional WM 08 audio modules, repeat the standard WM 08 pairing procedure.

### WM 08 Connectivity Icons

These icons appear on the top right of the EQUINOX LCD and show the WM 08 connectivity status. The number of connected WM 08 modules is indicated below the Wireless icon:

  	1 device connected
  	2 devices connected
  	3 devices connected
  	4 devices connected

### Charging the WM 08

 Going detecting with a fully charged WM 08 battery is recommended. Typical battery runtime is approximately 18 hours.

During operation, the WM 08 status LED will begin to flash red when the battery requires charging.

1. Plug the supplied charging cable into any standard powered USB-A port.
2. Connect the magnetic end of the charging cable to the WM 08 charging interface on the back of the module.
3. The LED will flash green whilst the unit is charging and remain on when the unit is fully charged.

The charge time from completely flat to 100% is approximately 3 hours when a high capacity (>1.7A @ 5V) charger is used.

### Connecting a Power Bank

Connecting the WM 08 to a power bank will allow you to continue to use it even if the battery is low/flat. The power bank will charge the WM 08, which will continue operating as normal.

# ML 80 Wireless Headphones

Wireless Bluetooth® aptX™ Low Latency headphones can be connected to EQUINOX for fast clear wireless audio and greater detecting freedom.

EQUINOX 800 is supplied with Minelab ML 80 Bluetooth® aptX™ Low Latency headphones. These headphones are also available separately as an accessory and are compatible with EQUINOX 600.

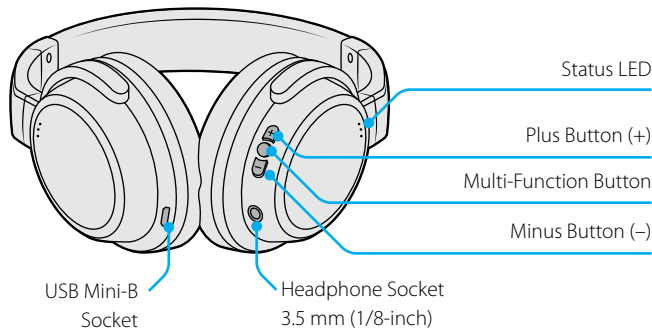

## Pairing Wireless Headphones

Pairing the ML 80 headphones is only required at first time use. EQUINOX will then automatically connect to the headphones for all future uses.

Re-pairing will be required if a different wireless device has been connected to the detector (e.g. WM 08), or following detector factory reset.

1. Ensure your wireless headphones are turned off and are no more than 1 metre (3-feet) away from the detector.
2. Press and hold the Multi-Function button on the ML 80 headphones until two ascending tones are heard and the LED alternates blue and red.
3. Press the wireless button on the side of the EQUINOX control panel for 2 seconds until the Wireless icon starts to flash rapidly.

*For first-time use of the EQUINOX, or following a factory reset, a short press of the Wireless button will immediately start the pairing sequence.*

4. The EQUINOX first attempts to pair with a WM 08 module for 15 seconds, indicated by the Wireless icon flashing on the LCD.

If a WM 08 is not found within this time, EQUINOX will then attempt to pair with Bluetooth® headphones for 5 minutes, or until pairing is complete. This is indicated by the Bluetooth® icon flashing on the LCD.

The Pairing process can be interrupted at any time by pressing the Wireless button.

5. If pairing is successful, the Bluetooth® and Wireless icons on the LCD will remain steady on. The headphones will beep and the Status LED will flash blue once every 3 seconds.

If the pairing is not successful within 5 minutes of being initiated, the headphones will go into standby mode.

## Turning Wireless Off

A short press of the Wireless button when wireless is active will switch Wireless off.

## Wireless Headphone Connection Icons

These icons appear on the top right of the LCD and show the wireless audio devices currently connected to your detector.

- Standard Bluetooth® headphones connected
- aptX™ Low Latency headphones connected

Turn Wireless off when you are not using it to conserve detector battery life.

## ML 80 Status LED

- Pairing (Alternating blue and red)
- Connected (Flash every 3 seconds)
- Headphones on, Not Connected (Flash every 2 seconds)
- Charging
- Charging complete (Off)

## Unpairing the ML 80 Headphones

Wireless headphones can be unpaired in the following ways:

- Factory reset of the detector
- Factory reset of headphones
- Attempting to connect a different wireless device of the same type (e.g. other Bluetooth® headphones). It is not possible to operate both the WM 08 and Bluetooth® headphones at the same time.

## Adjusting ML 80 Volume

The ML 80 headphones have their own volume control, which is independent of the detector volume.

Press the Plus (+) or Minus (-) buttons on the headphones to increase or decrease volume.



## ML 80 Factory Reset

Factory Reset will return the headphones to factory presets, and will unpair all paired wireless devices.

1. Turn the headphones off.
2. Press and hold the Multi-Function button for approximately 10 seconds, until the headphones beep twice and the Status LED flashes pink.
3. Release the button. The headphones will now be in pairing mode with the LED indicator flashing blue and red.

## Charging ML 80 Headphones



Going detecting with fully charged headphones is recommended.

ML 80 headphones have an internal Lithium-ion battery.

1. Connect the supplied charging cable to the USB socket in the headphones.
2. Connect the other end of the cable to a powered USB-A port.
3. The Status LED will turn red and remain on during charging.
4. Once the battery is fully charged, the LED will turn off.

## ML 80 Auxiliary Cable

ML 80 headphones come with a non-waterproof detachable auxiliary cable that connect to any standard 3.5 mm (1/8-inch) headphone socket for wired operation.

Therefore you can continue detecting, even if the headphones battery is flat, by connecting the cable from your headphones to the headphone socket on the rear of the EQUINOX control unit.

This cable can also be used to connect the headphones to the WM 08. WM 08 does not have a speaker and must be used with wired headphones.

## Smart Phone Call Functions

The ML 80 headphones can be paired with 2 devices at once, so you can also pair them with your smart phone. However, when a call is received it will interrupt the detecting audio.

### Answer a Call

When a call is incoming, the ring tone will be heard via the headphones. Press the Multi-Function button to accept the call.

### Reject / Ignore a Call

To reject / ignore an incoming call, press and hold the Multi-Function button for approximately 2 seconds until a beep is heard, then release the button.

### End a Call

Press the Multi-Function button to end a call.

### Transfer a Call

Press the Multi-Function button for 1 second, until a beep is heard, to transfer a call from the headphones to a smart phone. Repeat this procedure to transfer a call from a smart phone to the headphones.

### Last Number Redialling From the Headphones

In standby mode, double press the Multi-Function button on the headphones.

This function is only applicable to smart phones with Bluetooth® hands-free. Functionality will vary depending upon the smart phone model. Refer to your smart phone user guide for additional information.

## Smart Phone Music Functions

Once the ML 80 headphones have been paired to a smart phone, the headphones buttons can be used to remotely control the smart phone music functions.

If ML 80 headphones are connected to a phone that is playing music, and then connected to the detector, the detector audio will be automatically muted whilst the music is playing.

### Play / Pause Music

Press the Multi-Function button to play music that is paused.

Press the Multi-Function button to pause music that is playing.

When music is playing, the Status LED is steady blue.

### Next / Previous Track

Press and hold the Minus (-) button for 2 seconds to play the next track.

Press and hold the Plus (+) button for 2 seconds to play the previous track.

### Adjusting the Volume

Press the Plus (+) button to increase the volume by one level. When maximum volume is reached, there will be a high tone.

Press the Minus (-) button to decrease the volume by one level. When minimum volume is reached, there will be a low tone.

## Wired Headphones

The EQUINOX Series is compatible with any standard wired headphones. There are also accessory waterproof headphones available for underwater detecting.

### Connecting Wired Headphones

The EQUINOX 600 is supplied with wired headphones. Any standard 3.5 mm (1/8-inch) headphones can also be connected to EQUINOX, however the headphone connector overmold must be less than 9 mm (0.35") in diameter, otherwise the connector will not fit inside the waterproof socket.

The ML 80 wireless headphones come with an auxiliary cable that allows the headphones to be used as wired headphones.

1. Unscrew the plastic dust-cap from the headphone socket on the rear of the control unit. If it is tight, it can be loosened with a small coin.
2. Plug the headphones into the headphone socket.

 The Headphone icon will appear on the top right of the detector LCD.

 When headphones are not in use, ensure that the plastic dust-cap on the rear of the control unit is screwed firmly into place.

6.35 mm (1/4-inch) headphones can be used with EQUINOX via a headphone adaptor, available as an accessory.



### Connecting Waterproof Headphones

Both EQUINOX 600 and 800 are waterproof, and can be fully submerged to a depth of 3 metres (10-feet).

Minelab EQUINOX waterproof headphones must be used for underwater detecting, as they have a unique connector that forms a waterproof seal when used with your EQUINOX.

1. Unscrew the plastic dust-cap from the headphone socket on the rear of the control unit. If it is tight, it can be loosened with a small coin.
2. Check that the headphone socket and connector are dry and free from sand, dust, and dirt.
3. Plug the headphones into the connector on the rear of the control unit.
4. Carefully align the retaining ring over the connector thread and screw them together, ensuring that no cross-threading occurs.

 The Headphone icon will appear on the top right of the detector LCD.

5. Lightly tighten the retaining ring.

 After underwater detecting, ensure that the area around the connector is dry and free of sand and mud before disconnecting the headphones. This will prevent dirt and water ingress.



### Adaptor Cable



A headphone adaptor cable 6.35 mm (1/4-inch) to 3.5 mm (1/8-inch) is available to purchase as an accessory. It connects any 6.35 mm (1/4-inch) headphones to your detector or WM 08 Module.

 The 3.5 mm (1/8-inch) end of the Adaptor Cable is waterproof when screwed onto the EQUINOX waterproof headphone socket.

The 6.35 mm (1/4-inch) end is not waterproof.

### Headphone Socket Submersion

The headphone socket on the detector is waterproof, and will not be damaged if submerged without the plastic dust-cap attached.

However, if water enters the headphone jack it may cause false headphone detection. If this occurs, the detector speaker audio will cease and the headphones icon will appear on the LCD.

Resolve this by clearing the water from the headphones socket.



## Care & Safety

This section contains supplementary information on how to look after your EQUINOX, along with product technical specifications.

## EQUINOX Accessories

There is a range of quality accessories available to increase the versatility of your EQUINOX Series detector. [Go online to see the full range](#) →

### Smart Coils



**EQX 06 Double-D Smart Coil** | Part No. 3011-0333

The waterproof 6-inch round Double-D coil is very sensitive to small targets, and is perfect for finding treasure in high trash areas. It is also ideal for detecting in difficult terrain.



**EQX 11 Double-D Smart Coil** | Part No. 3011-0334 (Standard EQUINOX 600 | 800 coil)

The waterproof 11-inch round Double-D coil has good all-round performance for general detecting. It provides a good balance between sensitivity, weight, and ground coverage.



**EQX 15 Double-D Smart Coil** | Part No. 3011-0335

The waterproof 15 x 12-inch elliptical Double-D coil provides maximum depth for specialised treasure hunting. It is also great for wide ground coverage in open spaces.

All accessory coils come with a protective skidplate, two washers and a plastic nut and bolt. Skidplates are also available for individual purchase.

### Charging Accessories



**USB Charging Cable with Magnetic Connector** | Part No. 3011-0368

Connect to any standard powered USB port to charge the EQUINOX detector battery and the WM 08 audio module.



**2-Way USB Car Charger** | Part No. 3011-0375

Handy 2-way USB charger that plugs into a standard car charging socket so you can charge on the go.



**4-Way Universal AC Charger** | Part No. 3011-0374

A high capacity four-way USB AC charger with universal plug pack.

### Audio Accessories



**WM 08 Wireless Audio Module** | Part No. 3011-0371

Has a 3.5 mm (1/8-inch) headphone jack, and also has a threaded socket to use with EQUINOX waterproof headphones. Note that the WM 08 itself is not waterproof. USB charging cable with magnetic connector included.



**Minelab ML 80 Wireless Headphones** | Part No. 3011-0370

They use standard Bluetooth® technology, but also have enhanced, super-fast apt-X™ Low Latency technology for minimal time delay. They can also be connected directly to the detector's headphone socket for wired use, via the supplied auxiliary cable.



**Waterproof EQUINOX Headphones** | Part No. 3011-0372

Waterproof headphones with 3.5 mm (1/8-inch) EQUINOX connector. They can also be connected to a WM 08 Wireless Audio Module.



**Headphones (wired) 3.5 mm / 1/8-inch** | Part No. 3011-0364

Wired headphones that connect to any standard 3.5 mm (1/8-inch) headphone socket.



**Headphone Adaptor Cable 3.5 mm (1/8-inch) to 6.35 mm (1/4-inch)** | Part No. 3011-0369

Connect any 6.35 mm (1/4-inch) headphones to your detector or WM 08 Module with this handy adaptor.

## Maintenance & Safety

The EQUINOX is a high-quality electronic instrument, finely engineered and packaged in a durable housing. Taking proper care of your detector is vital to ensure its ongoing reliability.

### General Detector and Accessories Care

- Do not use solvents to clean. Use a damp cloth with a mild soap detergent.
- Do not leave in excessive heat/cold for longer than necessary (e.g. in a car or outside overnight).
- Do not expose accessories not listed as waterproof to liquid/moisture or excessive humidity.
- Do not allow children to play with the detector or accessories, small parts are a choking hazard.
- Do not open or mutilate the internal batteries.
- Dispose of batteries as per local regulations.
- Only charge the detector and accessories according to the instructions in this manual.
- Avoid charging the detector and accessories in extreme temperature conditions.
- Do not dispose of the detector or accessories in a fire as this may result in an explosion.
- Do not bring the detector or accessories into contact with sharp objects as this may cause scratches and damage.
- Ensure the coil cable is in good condition and not subject to undue stress.
- Take precautions when transporting or storing the detector. Although the detector is constructed from the highest quality materials and has undergone rigorous durability tests, the display screen could be prone to scratching or serious damage if not treated with due care.
- Do not expose the detector to extreme temperature conditions. The storage temperature range is from -20°C to +50°C (-4°F to +122°F).

### ML 80 Headphones Care

- Check local laws regarding the use of smart phones and headphones whilst driving. If you use the headphones whilst driving, ensure your attention and focus remains on the road and you drive in a responsible and safe manner.
- Observe all signs that require an electrical device or RF radio product to be switched off in designated areas. These could include hospitals, blasting areas, and potentially explosive environments.
- Turn off your headphones prior to boarding an aircraft.
- Never mount or store your headphones over any air bag deployment area as serious injury may result if the air bag deploys.
- Turn the headphones off before placing in a pocket or bag. If the Multi-Function button is accidentally activated, your smart phone may place an unintended call if paired.
- Do not expose the headphones to liquid, moisture or humidity, as the headphones are not waterproof.
- Do not expose the headphones to extreme temperature conditions. The storage temperature range is from 0 to +60°C (32°F to +140°F).

























### EQUINOX Detector Care

- Wash your hands before handling the detector after applying sunscreen or insect repellents.
- If water gets into the headphone socket, it must be dried carefully with a warm air dryer in order to prevent corrosion and/or false headphone connection detection.
- O-ring lubricant or grease is not required on waterproof seals.
- Do not use a petroleum based O-ring grease as it is likely to damage the waterproof seals.
- Do not leave the detector in excessive cold or heat longer than necessary. Covering it when not in use will help protect it. Avoid leaving it in a hot vehicle.
- Never allow the detector to come into contact with gasoline/petrol or other petroleum-based liquids.
- Avoid getting sand and grit in the shafts and fastenings (e.g. coil yoke assembly and twist locks).
- If the upper or lower shafts become noticeably scratched, wipe them thoroughly with a damp cloth.
- Hose the detector with clean water after use on the beach (wading or submersion).



## Factory Presets

The factory preset detector settings are optimised for ease of use. They will help you start detecting successfully with minimal adjustment.

### Detect Mode Search Profiles

	 Park 1	 Park 2	 Field 1	 Field 2	 Beach 1	 Beach 2	 Gold 1*	 Gold 2*
 Frequency	Multi	Multi	Multi	Multi	Multi	Multi	Multi	Multi
 Noise Cancel	0	0	0	0	0	0	0	0
 Ground Balance	Manual, 0	Manual, 0	Manual, 0	Manual, 0	Manual, 0	Manual, 0	 Tracking	 Tracking
 Volume Adjust	20							
 Tone Volume	12, 25, 25, 25, 25	12, 25	4, 25	4, 25	4, 25, 25, 25, 25	4, 25, 25, 25, 25	—	—
 Threshold Level	0						12	
 Threshold Pitch*	4						11	
 Target Tone	5	50	2	50	5	5	1	1
 Tone Pitch	1, 6, 12, 18, 25	1, 20	1, 20	1, 20	1, 6, 12, 18, 25	1, 6, 12, 18, 25	—	—
 Accept/Reject	✗ -9 to 1 ✓ 2 to 40	✗ -9 to 0 ✓ 1 to 40	✗ -9 to 2 ✓ 3 to 40	✗ -9 to 2 ✓ 3 to 40	✗ -9 to 0 ✓ 1 to 40	✗ -9 to 0 ✓ 1 to 40	✗ -9 to 0 ✓ 1 to 40	✗ -9 to 0 ✓ 1 to 40
 Tone Break	0, 10, 20, 30	0	2	2	0, 10, 20, 30	0, 10, 20, 30	—	—
 Recovery Speed	3, 5*	3, 6*	3, 6*	3, 7*	3, 6*	3, 6*	6	4
 Iron Bias Profile	FE	FE	FE	FE	FE	FE	FE	FE
Iron Bias FE	2, 6*	0	0	0	2, 6*	2, 6*	6	6
Iron Bias F2	2, 6*	2, 6*	2, 6*	2, 6*	2, 6*	2, 6*	6	6
 Sensitivity	20							
 Backlight	Off							

### 1, 2, 5 and 50 Tones Advanced Settings Presets

	Park 1	Park 2	Field 1	Field 2	Beach 1	Beach 2	Gold* 1	Gold* 2
 Tone Volume								
1 Tone	25	25	25	25	25	25	25	25
2 Tones	12, 25	12, 25	4, 25	4, 25	4, 25	4, 25	—	—
5 Tones	12, 25, 25, 25, 25	12, 25, 25, 25, 25	4, 25, 25, 25, 25	4, 25, 25, 25, 25	4, 25, 25, 25, 25	4, 25, 25, 25, 25	—	—
50 Tones	12, 25	12, 25	4, 25	4, 25	4, 25	4, 25	—	—
 Tone Pitch								
1 Tone	11	11	11	11	11	11	—	—
2 Tones	1, 20	1, 20	1, 20	1, 20	1, 20	1, 20	—	—
5 Tones	1, 6, 12, 18, 25	1, 6, 12, 18, 25	1, 6, 12, 18, 25	1, 6, 12, 18, 25	1, 6, 12, 18, 25	1, 6, 12, 18, 25	—	—
50 Tones	1, 20	1, 20	1, 20	1, 20	1, 20	1, 20	—	—
 Tone Break								
2 Tones	0	0	2	2	0	0	—	—
5 Tones	0, 10, 20, 30	0, 10, 20, 30	2, 10, 20, 30	2, 10, 20, 30	0, 10, 20, 30	0, 10, 20, 30	—	—
50 Tones	0	0	2	2	0	0	—	—

# Troubleshooting

If you experience any of the listed problems, try the recommended actions first before contacting an Authorised Service Centre.

Problem	Recommended Action
Detector does not turn on	<ol style="list-style-type: none"> <li>1. Connect the EQUINOX USB charger to the detector and a power source. If the detector functions then the detector is OK. Wait for the charging indicator to stop flashing to indicate that the detector is fully charged.</li> <li>2. Remove the EQUINOX USB charger – if the detector powers off immediately, the battery needs replacing.</li> </ol>
Detector turns on, but turns off by itself	<ol style="list-style-type: none"> <li>1. Ensure the battery is sufficiently charged.</li> </ol>
Erratic noises	<ol style="list-style-type: none"> <li>1. Move away from local sources of Electromagnetic Interference (EMI).</li> <li>2. Perform an Automatic Noise Cancel.</li> <li>3. Perform Ground Balance.</li> <li>4. Reduce the Sensitivity level.</li> </ol>
No sound – Wired headphones	<ol style="list-style-type: none"> <li>1. Check that the detector is on, and start-up has completed.</li> <li>2. Check that Volume (including Tone Volume Tone Regions) is set to an audible level (e.g. 20).</li> <li>3. Check that the headphones are plugged in.</li> <li>4. Unplug the headphones and confirm that the speaker is audible.</li> <li>5. If available, try using a different set of headphones.</li> </ol>
No sound – WM 08	<ol style="list-style-type: none"> <li>1. Check that the WM 08 is on and the blue LED is illuminated (not flashing). If slow flashing, check detector Wireless is turned on. If fast flashing, check detector Wireless is in pairing.</li> <li>2. If the WM 08 does not turn on, try recharging it.</li> <li>3. Confirm the 'Wireless' setting is set to 'On'.</li> <li>4. Plug headphones directly into the detector to verify that the headphones are not the problem.</li> <li>5. Check that Volume (including Tone Volume Tone Regions) is set to an audible level (e.g. 20). If the WM 08 is not connected, the speaker will be audible.</li> <li>6. If the Bluetooth® icon appears on the LCD, then WM 08 is not connected.</li> <li>7. Try re-pairing the WM 08 to the detector.</li> <li>8. If available, try using a different set of headphones connected to the WM 08.</li> </ol>
No sound – Bluetooth® Headphones	<ol style="list-style-type: none"> <li>1. Check that the headphones are turned on.</li> <li>2. Check that Wireless is turned on and paired with Bluetooth® headphones.</li> <li>3. Check that the headphones are charged.</li> <li>4. Check that the detector Volume is set to an audible level (e.g. 20).</li> <li>5. Ensure the volume control on the headphones is turned up.</li> <li>6. Try wired headphones.</li> <li>7. Try a different set of Bluetooth® headphones.</li> </ol>
ML 80 Headphones will not pair	<ol style="list-style-type: none"> <li>1. Try powering off the ML 80 headphones and then re-pair. Read '<a href="#">Pairing Wireless Headphones</a>' on page 56.</li> <li>2. Ensure the headphones are within 1 metre (3-feet) of the detector control unit, with no obstructions between the headphones and detector (including your own body).</li> <li>3. Move away from sources of interference such as mobile phones.</li> <li>4. If there are many other Bluetooth® devices nearby, pairing may take longer. Move away from the area and try to pair again.</li> <li>5. Perform a factory reset on the headphones and attempt to re-pair to the detector.</li> <li>6. Pair the detector with a WM 08 or different Bluetooth® headphones, then attempt to re-pair ML 80 headphones to the detectors.</li> </ol>
Distortion/Crackling heard in ML 80 Headphones when connected via Bluetooth®.	<ol style="list-style-type: none"> <li>1. Reduce the volume on the headphones until distortion is removed. Increase detector volume if required to compensate for the reduced volume.</li> </ol>
Speaker is squeaky or muffled after submersion in cold water	<ol style="list-style-type: none"> <li>1. Allow up to half an hour for the detector internal air pressure to return to normal.</li> </ol>
Headphone icon is on, but no headphones are connected	<ol style="list-style-type: none"> <li>1. Check that the headphone socket is clear of water and obstructions.</li> <li>2. If water is present, use a warm air dryer to dry the connector.</li> </ol>
Shaft twist-lock seizes	<ol style="list-style-type: none"> <li>1. Separate the shafts and turn the twist lock back and forth several times to clear any dirt build-up, then thoroughly rinse in clean water before putting back together.</li> </ol>

## Error Codes

Some detector faults will display an error code on the Target ID Display.

Error Code	Recommended Action
<p><b>Cd</b> Coil is disconnected</p>	<ol style="list-style-type: none"> <li>1. Check that the coil connector is connected properly at the back of the control unit.</li> <li>2. Check the coil cable for damage.</li> <li>3. Check the coil for visible signs of damage.</li> <li>4. Try another coil, if you have one available.</li> </ol>
<p><b>bF</b> Critically low battery</p>	<ol style="list-style-type: none"> <li>1. Recharge the battery.</li> <li>2. Connect a USB power bank.</li> <li>3. Contact an Authorised Service Centre to replace the internal battery.</li> </ol>
<p><b>Er</b> System error</p>	<p>System error code 'Er' will be accompanied by an error code number shown on the Frequency Display. The detector will shut down 5 seconds after reporting a system error.</p> <p>In the event of a system error, please follow these steps:</p> <ol style="list-style-type: none"> <li>1. Restart the detector to determine if the error still remains.</li> <li>2. Confirm the coil is attached correctly.</li> <li>3. If the error persists, perform a factory reset by pressing and holding in the Power button for 5 seconds.</li> <li>4. If the error still remains, please return the detector to your nearest Authorised Service Centre for repair.</li> </ol>



# Technical Specifications

## EQUINOX Detector Specification

	EQUINOX 600	EQUINOX 800
<b>Detect Modes</b>	Park   Beach   Field	Park   Beach   Field   Gold
<b>Custom Search Profiles</b>	6 (2 per Detect Mode)	8 (2 per Detect Mode)
<b>User Profile Button</b>	No	Yes
<b>Operating Frequencies (kHz)</b>	Multi   4   5   10   15	Multi   4   5   10   15   20   40
<b>Noise Cancel</b>	Auto	Auto   Manual (-9 to 9)
<b>Ground Balance</b>	Auto   Manual	
<b>Sensitivity</b>	1 to 25	
<b>Target Volume</b>	0 to 25	
<b>Threshold Level</b>	0 to 25	
<b>Threshold Pitch</b>	Fixed	0 to 25
<b>Target Identification</b>	50 segment notch discrimination: Ferrous: -9 to 0   Non-ferrous: 1 to 40	
<b>Target Tones</b>	1   2   5   50	
<b>Tone Break</b>	Ferrous	Ferrous   Non-ferrous
<b>Tone Pitch</b>	Ferrous	Ferrous   Non-ferrous
<b>Tone Volume</b>	Ferrous	Ferrous   Non-ferrous
<b>Recovery Speed</b>	1 to 3	1 to 8
<b>Iron Bias</b>	0 to 3	0 to 9
<b>Depth Indicator</b>	5 levels	
<b>Length (assembled)</b>	Extended: 1440 mm (56.7")   Collapsed: 1120 mm (44.1")	
<b>Weight</b>	1.34 kg (2.96 lbs)	
<b>Standard Coil</b>	EQX 11:11-inch Double-D Smart coil with skidplate (waterproof to 3m/10')	
<b>Audio Output</b>	Speaker   3.5 mm (1/8") headphones (included)   Bluetooth® aptX™ Low Latency compatible   WM 08 Wi-Stream compatible	
<b>Headphones (included)</b>	Wired 3.5 mm (1/8") (non-waterproof)	Bluetooth® aptX™ Low Latency (non-waterproof)
<b>WM 08 (included)</b>	No	Yes
<b>Display</b>	Monochrome LCD with backlight	
<b>LCD Backlight</b>	Off   High   Low	Off   High   Medium   Low
<b>Battery</b>	Internal rechargeable Lithium-ion battery 5000 mAh	
<b>Battery Life</b>	Approximately 12 hours	
<b>Battery Charge Time</b>	Approx. 4 hours (When charging via a >1.7A @ 5V USB port)	
<b>Waterproof</b>	Waterproof to 3m/10-feet	
<b>Operating Temperature Range</b>	-10°C to +50°C (+14°F to +122°F)	
<b>Storage Temperature Range</b>	-20°C to +50°C (-4°F to +122°F)	
<b>Charging Temperature Range</b>	0°C to +40°C (+32°F to +104°F)	
<b>Key Technologies</b>	Multi-IQ   4F×4   Wi-Stream   Bluetooth® aptX™ Low Latency	Multi-IQ   6F×11   Wi-Stream   Bluetooth® aptX™ Low Latency
<b>Other Accessories</b>	USB Charging cable, Multi Language Screen protectors	
<b>Software Upgradeable</b>	Yes, via USB connection (Windows and Mac OS)	
<b>Warranty</b>	Register your product warranty online at <a href="http://register.minelab.com">register.minelab.com</a> . Please refer to <a href="http://www.minelab.com/warranty-conditions">www.minelab.com/warranty-conditions</a> for full warranty terms and conditions.	



Minelab reserves the right to respond to ongoing technical progress by introducing changes in design, equipment and technical features at any time. For the most up-to-date specifications for EQUINOX 600 and 800, visit [www.minelab.com](http://www.minelab.com).

## WM 08 Specification

<b>Wireless Operating Range</b>	Up to 5 metres (15-feet)
<b>Weight</b>	65 g (2.3 oz)
<b>Dimensions</b>	59 mm × 59 mm × 27 mm (2.3" × 2.3" × 1.1")
<b>Charging Time</b>	Approximately 3 hours
<b>Battery</b>	Internal rechargeable Lithium-ion battery
<b>Battery Life</b>	Approx. 18 hours
<b>Operating Temperature Range</b>	-10°C to +50°C (+14°F to +122°F)
<b>Storage Temperature Range</b>	-20°C to +50°C (-4°F to +122°F)
<b>Charging Temperature Range</b>	0°C to +40°C (+32°F to +104°F)
<b>Waterproof</b>	No
<b>Wireless Technologies</b>	Wi-Stream™
<b>Software Upgradeable</b>	No
<b>Detector Compatibility</b>	EQUINOX Series
<b>Warranty</b>	Register your product warranty online at <a href="http://register.minelab.com">register.minelab.com</a> . Please refer to <a href="http://www.minelab.com/warranty-conditions">www.minelab.com/warranty-conditions</a> for full warranty terms and conditions.

## Software Updates

EQUINOX Series detector have the ability to accept software updates via USB.

Visit [www.minelab.com](http://www.minelab.com) for up-to-date EQUINOX Software and installation instructions.

## ML 80 Wireless Headphones Specification

<b>Bluetooth® Version</b>	V4.1
<b>Bluetooth® Modes Supported</b>	<ul style="list-style-type: none"> <li>• Headphones</li> <li>• Hands-free</li> <li>• A2DP</li> <li>• AVRCP</li> <li>• aptX™</li> <li>• aptX™ Low Latency</li> </ul>
<b>Bluetooth® Chipset</b>	CSR8670 with aptX™   aptX™ Low Latency
<b>Wireless Operating Range</b>	Up to 10 metres (30-feet)
<b>Weight</b>	221 g (7.8 oz)
<b>Dimensions (unfolded)</b>	210 mm × 160 mm × 80 mm (8.3" × 6.3" × 3.2")
<b>Battery</b>	Internal rechargeable Lithium-ion battery
<b>Battery Life</b>	Detecting: Approximately 28 hours Standby: Up to 180 hours
<b>Charging Time</b>	Approximately 3 hours (When charging via a >1.7A @ 5V USB port)
<b>Operating Temperature Range</b>	-10°C to +50°C (+14°F to +122°F)
<b>Storage Temperature Range</b>	0 to +60°C (32°F to +140°F)
<b>Charging Temperature Range</b>	0°C to +40°C (+32°F to +104°F)
<b>Waterproof</b>	No
<b>Wireless Technologies</b>	Bluetooth®   aptX™ Low Latency
<b>Other Accessories</b>	3.5 mm (1/8-inch) detachable auxiliary cable
<b>Warranty</b>	Register your product warranty online at <a href="http://register.minelab.com">register.minelab.com</a> . Please refer to <a href="http://www.minelab.com/warranty-conditions">www.minelab.com/warranty-conditions</a> for full warranty terms and conditions.

**CAUTION:**

Before assembling, charging, or using your detector for the first time, please read the important legal and safety information in this manual.

Use of this appliance by children aged less than 8 years is prohibited.

This appliance can be used by children aged from 8 years and above and by persons with reduced physical or mental capabilities if they have been given supervision or instruction concerning use of the appliance in a safe way and understand the hazards involved.

Cleaning and user maintenance shall not be made by children without supervision.

**COMPLIANCE**

THIS DEVICE COMPLIES WITH PART 15 OF THE FCC RULES. OPERATION IS SUBJECT TO THE FOLLOWING TWO CONDITIONS: (1) THIS DEVICE MAY NOT CAUSE HARMFUL INTERFERENCE, AND (2) THIS DEVICE MUST ACCEPT ANY INTERFERENCE RECEIVED, INCLUDING INTERFERENCE THAT MAY CAUSE UNDESIRE OPERATION.

**Information to the User (FCC Part 15.105)****NOTE: Class B Devices**

This equipment has been tested and found to comply with the limits for a Class B digital device, pursuant to part 15 of the FCC Rules. These limits are designed to provide reasonable protection against harmful interference in a residential installation.

This equipment generates, uses and can radiate radio frequency energy and, if not installed and used in accordance with the instructions, may cause harmful interference to radio communications. However, there is no guarantee that interference will not occur in a particular installation. If this equipment does cause harmful interference to radio or television reception, which can be determined by turning the equipment off and on, the user is encouraged to try to correct the interference by one or more of the following measures:

- Reorient or relocate the receiving antenna
- Increase the separation between the equipment and receiver
- Connect the equipment into an outlet on a circuit different from that to which the receiver is connected
- Consult the dealer or an experienced radio/TV technician for help

**EU declaration of conformity**

- Hereby, Minelab Electronics Pty Ltd declares that the radio equipment type EQUINOX 600/800 is in compliance with Directive 2014/53/EU.
- The full text of the EU declaration of conformity is available at the following internet address:
- [www.minelab.com/compliance](http://www.minelab.com/compliance)

**RADIO FREQUENCY SPECIFICATION**

	Frequency	Power
<b>Detector</b>	3.7 to 40 kHz	< -30 dBm
<b>Bluetooth</b>	2.4 to 2.483 GHz	-5.9 dBm
<b>WiStream</b>	2.4 to 2.483 GHz	-0.5 dBm

**Bluetooth® aptX™ Low Latency**

The EQUINOX detector makes use of the Bluetooth® aptX™ Low Latency protocol for audio compression to deliver a superior wireless audio experience.

The Bluetooth® word mark and logos are registered trademarks owned by the Bluetooth SIG, Inc. and any use of such marks by Minelab is under license.

Qualcomm aptX is a product of Qualcomm Technologies, Inc. and/or its subsidiaries.

Qualcomm is a trademark of Qualcomm Incorporated, registered in the United States and other countries. aptX is a trademark of Qualcomm Technologies International, Ltd., registered in the United States and other countries.

**DISCLAIMER**

The Minelab metal detector discussed in this instruction manual has been expressly designed and manufactured as a quality metal detector and is recommended for treasure and gold detecting in non-hazardous environments. This metal detector has not been designed for use as a mine detector or as a live munitions detection tool.

**PLEASE NOTE**

Since there may be a variety of options available for this detector, equipment may vary according to the Model or items ordered with your detector. Certain descriptions and illustrations may also differ (in this manual) from the exact Model that you purchased. In addition, Minelab reserves the right to respond to ongoing technical progress by introducing changes in design, equipment and technical features at any time.

Minelab®, EQUINOX®, Multi-IQ®, Wi-Stream™, 5F×8™ and 3F×3™ are trademarks of Minelab Electronics Pty. Ltd.



This work is licensed under the Creative Commons Attribution-NonCommercial-NoDerivatives 4.0 International License.

To view a copy of this license, visit:

<http://creativecommons.org/licenses/by-nc-nd/4.0/>

© MINELAB ELECTRONICS PTY LTD.



Qualcomm® aptX™  
Low Latency



[www.minelab.com](http://www.minelab.com)

SHOP DETECTORS  
TEL : +1 206-401-9788  
WEB : <https://shopdetectors.com/>  
EMAIL : [contact@shopdetectors.com](mailto:contact@shopdetectors.com)