

# TEKNETICS® T<sup>2</sup><sup>TM</sup>

Professional Metal Detector

## Comprehensive Operating Manual and Guide to Metal Detecting



**T**he Teknetics® **T<sup>2</sup>** is a new high-performance multi-purpose professional grade metal detector. It utilizes the latest advances in electronic technology, and its functional design represents the leading edge of the metal detector engineering art. The **T<sup>2</sup>** is easier to learn to use properly than other comparable metal detectors. Its combination of light weight and balance provides comfort unmatched by any other detector in its price range. Its most popular uses include coinshooting, relic hunting, and gold prospecting.

## ***PRODUCT FEATURES***

---

- Simple, easy-to-use controls
- Large LCD screen with target identification and operating control displays
- Straightforward menu-driven user interface
- Bar graph readout of ground mineral concentration
- Trigger-actuated FASTGRAB™ ground canceling with manual override
- Waterproof 11-inch open-frame BiAxial™ searchcoil
- Single-Filter All Metal Mode for maximum detection depth
- Double-Filter Discrimination Modes for searching in trashy areas
- Trigger-actuated target pinpointing with variable audio pitch

If you have any questions, or need assistance with your metal detector, Call 1-800-413-4131, and ask for Teknetics® Customer Service.

Copyright© First Texas Product, L.L.C. 2019

# TABLE OF CONTENTS

<b>Quick-Start</b> .....	4
<b>Mechanicals</b>	
Assembly .....	5
Batteries .....	6
Armrest .....	6-7
Headphones (not included) .....	7
<b>Introduction to the Teknetics® T<sup>2</sup></b>	
General information .....	8
Specifications .....	9
Controls .....	10
Menu System .....	11
Ground Cancellation .....	12-14
All Metal Mode .....	15
Discrimination Mode .....	16-17
PinPoint Feature .....	18
LCD Visual Display .....	19-21
Numeric Target Identification .....	19
Probable Target Identification .....	19
Target Depth .....	20
G.C. Phase .....	20
Settings .....	20
Messages .....	20
Bar Graph .....	21
Battery Indicator .....	21
Frequency Shifting .....	21
Capabilities & Limitations .....	22-24
<b>Tips &amp; Techniques</b>	
Search Techniques	
Sweep Searchcoil .....	25
Pinpointing targets .....	26-27
Estimating Target Size, Depth and Shape .....	27-28
False signals and chatter .....	28-30
Adjusting Sensitivity using the Sensitivity Control .....	29
Tips On Ground Canceling .....	30
Detecting Activities	
Coinshooting .....	31
Relic Hunting .....	31-32
Gold Prospecting .....	32-35
Cache Hunting .....	35-36
Shallow Water Hunting .....	36
How metal detectors work .....	37
Treasure Hunter's Code of Ethics .....	38
Warranty .....	39
<b>Accessories</b> .....	Back Cover

## **QUICK START**

---

### *Start using your T<sup>2</sup> right out of the box*

1. Assemble the detector (see instructions beginning page 5-6).
2. Install four AA **alkaline** batteries. **All positive terminals point up.**
3. Turn the knob, located under the armrest, fully clockwise.  
This turns the machine on and sets audio volume to maximum.
4. When first turned on, the **T<sup>2</sup>** starts out in the All-Metal Mode, with:  
Sensitivity preset to 60  
Hum Level preset to +1  
Sweep the searchcoil from side to side, parallel to the ground. Keep the searchcoil moving over the ground. If you stop moving the searchcoil, the sound will also stop.  
Probable target type will be indicated at the top of the LCD screen.
5. If the searchcoil is not in motion and not close to metal, the detector should be silent.
6. If you experience false signals from electrical interference, from the soil itself, or from lots of trash metal, press the Menu button.  
**Sensitivity** will be highlighted.  
Rotate the **Settings** knob to the left (counterclockwise),  
Reduce the sensitivity setting until the false signals go away.  
After 5 seconds, the machine will exit the menu and return to normal operation.
7. Toss a coin on the ground and sweep back and forth over it a few times to get a feel for how the machine responds.
8. You are now ready to search.
9. Pull the trigger switch with your index finger to pinpoint the exact location of targets, making them easier to unearth.

When the trigger is pulled, PinPoint is engaged ....

The searchcoil need not be in motion to detect an object.

The 2-digit numeric display indicates approximate target depth, in inches.

**MECHANICALS**

**Caution:** Forcing in MIDDLE STEM with CAM LOCK raised may form a burr on camlock. If this happens, remove burr with knife to allow insertion.

**Assembly**

- 1 Position S-Rod upright.
- 2 Rotate the LOCKING COLLAR fully in the counterclockwise direction.
- 3 Insert your finger inside the tube and make sure the INTERNAL CAM LOCK is flush with the inside of the tube.

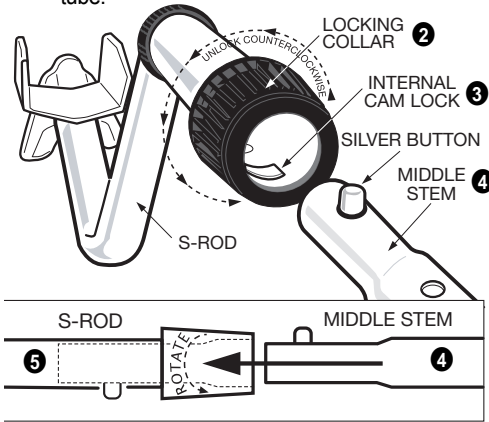

- 4 Insert the MIDDLE STEM into the S-ROD, with the SILVER BUTTON pointed upward
- 5 Rotate the MIDDLE STEM until the SILVER BUTTON locates in the hole.
- 6 Twist the LOCKING COLLAR fully in the clockwise direction until it locks.
- 7 Repeat this process on the LOWER STEM.
- 8 Using the BOLT and KNURLED KNOB, attach the SEARCHCOIL to the LOWER STEM.
- 9 Adjust the LOWER STEM to a length that lets you maintain a comfortable upright posture, with your arm relaxed at your side, and the SEARCHCOIL parallel to the ground in front of you.
- 10 Wind the CABLE securely around the STEMS.
- 11 Connect CABLE PLUG to housing. Do not twist the Cable or Plug. Turn Locking Ring only. Use minimal finger pressure to start the threads. Do not cross-thread. When the Locking Ring is fully engaged over the threaded connector, give it a firm turn to make sure that it is very tight. When the Locking Ring is fully engaged over the threaded connector, it may not cover all of the threads.
- 12 Tighten both LOCKING COLLARS.

\* Note: Very tall users can purchase the optional Extended Lower Stem (TUBE5X), for extended reach.

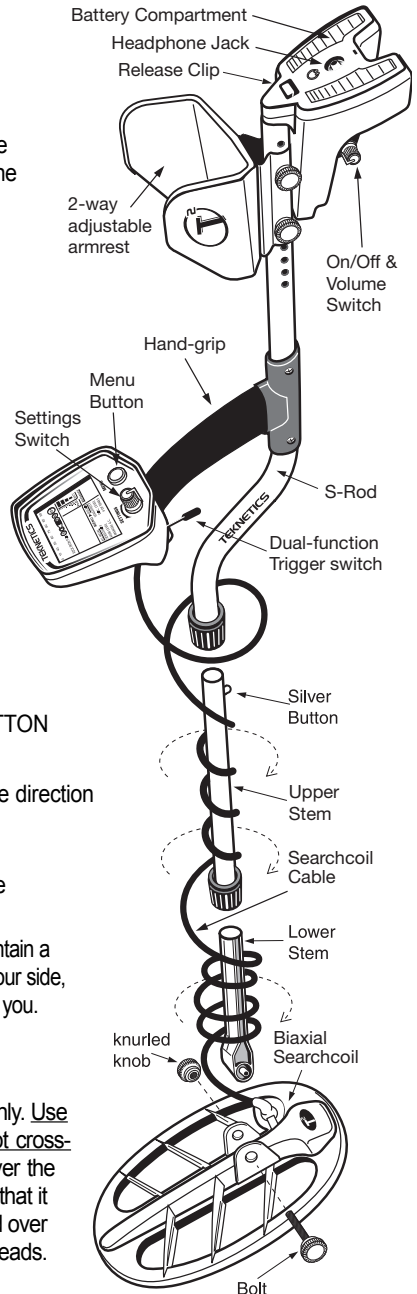

## **MECHANICALS (continued)**

### **BATTERIES**

The  $T^2$  uses four AA batteries. Use ALKALINE batteries for best performance. Rechargeable batteries may be used. Expect 40 hours of service in the field with one set of ALKALINE batteries.

If you use rechargeable batteries, good-quality NiMH (nickel-metal-hydride) batteries are recommended. They will usually deliver over 25 hours of service without recharging, but when they start running low, they die suddenly with little warning.

Always install batteries which are of the same type and the same state of charge. Otherwise battery life will be determined by the weakest battery, as the good batteries cannot deliver their power with a dead battery blocking the current.

All 4 batteries are installed with the **positive terminals facing upward**.

The LCD screen shows battery condition on the right.

#### **DO NOT MIX OLD AND NEW BATTERIES**

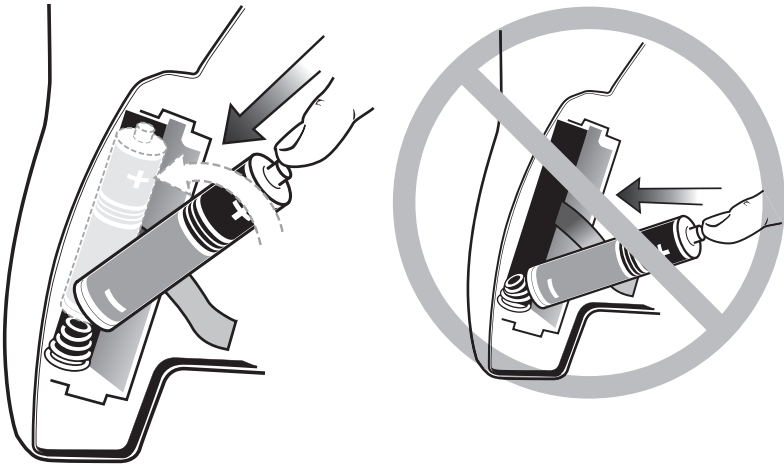

### **ARMREST**

The armrest WIDTH and POSITION are both adjustable.

**Armrest Width:** The sides of the armrest can be bent inward and outward.

To best stabilize the detector to your arm and body movement, squeeze the sides of the armrest around your forearm. For a very secure fit, some users prefer to bend the armrest in tightly against the forearm such that you pry the sides loose each time you place your arm into the armrest.

## MECHANICALS (continued)

**Armrest Position on Pole:** Remove the two bolts to position the armrest farther forward or back, to adapt to your arm's length.

- To reinsert the bolts, spin and twist them into place. Be careful not to damage the power cable that runs through the aluminum tube.
- Insert both bolts completely through both sides of the bracket *before attaching the nut* to the opposite side.
- For maximum stability, the bolts fit very tightly into the holes; you may have to wiggle each one a bit to push it through the holes.
- After reinserting the bolts, tighten them very securely. As you swing the detector from side-to-side, you want the bolts tight enough so that you do not feel any movement between the pole and armrest mounting bracket.

**If you notice unwanted movement while swinging detector, check the tightness of the locking collars.** The locking collars must be rotated a full 270° to reach the locking position.

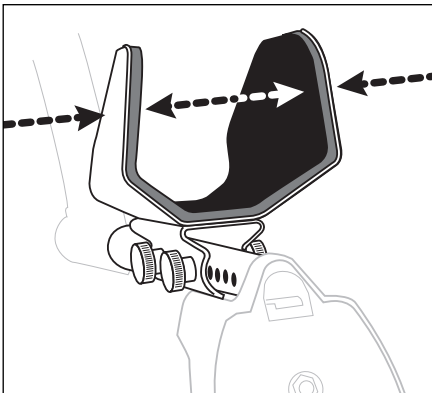

Adjust the armrest in or out accordingly

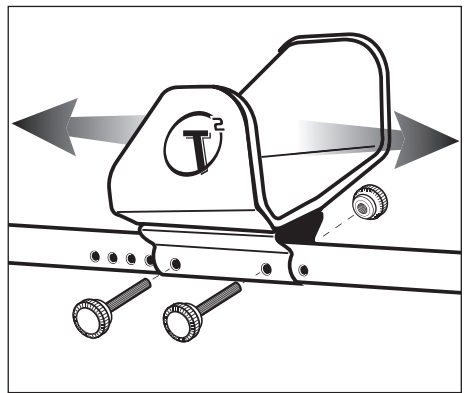

Adjust the armrest forward or back, to adapt to your arm's length.

## HEADPHONES (not included)

The T<sup>2</sup> is equipped with a standard 1/4-inch stereo headphone jack at the rear of the unit, located under the elbow as you hold the detector for use. Any headphone with a 1/4" stereo jack should work. Mono headphones will not work.

Using headphones improves battery life, and prevents the sounds from annoying bystanders. It also allows you to hear subtle changes in the sound more clearly, particularly if searching in a noisy location.

For safety reasons, do not use headphones near traffic or where other dangers, like rattlesnakes, are present.

This device is to be used with interconnecting cables/headphone cables shorter than three meters.

# ***Introduction to the Teknetics® T<sup>2</sup>***

---

## ***General Information***

**HIGH PERFORMANCE** The *Teknetics® T<sup>2</sup>* is a multi-purpose high-performance computerized metal detector. It has the high sensitivity and ground cancellation features needed for professional gold prospecting, the discrimination responsiveness needed for serious relic hunting under difficult conditions, and visual Target-ID considered essential in searching for coins. The ground cancellation system can be adjusted to allow searching salt water beaches. The *T<sup>2</sup>* operates at 13 kHz for good sensitivity to gold nuggets and jewelry as well as to coins. The *T<sup>2</sup>* comes with an 11-inch elliptical Bi-Axial searchcoil for maximum detection depth in mineralized soils.

**USER COMFORT** The *T<sup>2</sup>* is light weight and the best balanced of any high-performance metal detectors, so you can hold and swing it almost effortlessly. The armrest position is adjustable to fit your arm. The grip is durable high-friction foam elastomer, comfortable in any kind of weather. The controls are conveniently located and easy to learn how to use. Locking collars on the tubes eliminate rattling.

**EASY-TO-USE & INFORMATIVE INTERFACE** The entire menu is always visible on the LCD display. The LCD display indicates the electrical signature (Target-ID) of the detected metal object. The display provides continuous information on battery condition and on ground mineralization, which affects detection depth. Help messages are automatically displayed on the lower right corner of the display when necessary.

**LOW OPERATING COST** The *T<sup>2</sup>* is powered by four AA alkaline batteries, which will typically last for more than 40 hours of use before needing replacement.

**DESIGNED BY EXPERIENCED ENGINEERS** The lead engineers on the *T<sup>2</sup>* design team were John Gardiner, firmware engineer, and David Johnson, whose expertise is behind many of the best-known high-performance metal detectors offered by major U.S. manufacturers for the last 26 years.



## **SPECIFICATIONS**

---

**Mechanical:** S-rod with electronics housing mounted on handgrip, 3-piece breakdown, batteries under elbow, 2-way armrest adjustment — forward/backward & around forearm.

**Searchcoil:** 11" (28 cm) open-frame elliptical double-D, waterproof.

**Batteries:** 4 AA, alkaline or NiMH (not included).

**Weight:** 3.5 pounds (1.6 kg) with alkaline batteries installed.

**Static Balance:** force in vertical plane normal to elbow 0.47 pounds (0.22 kg). Varies with adjustment and user's stance and arm/hand physiology.

**Dynamic Balance:** axial moment, 0.29 foot-pounds (0.39 newton-meters). Varies with adjustment and user's stance and arm/hand physiology.

**Sweep Effort:** lateral moment 5.2 foot-pounds (7.1 newton-meters).

**Operating Principle:** VLF induction balance

**Operating Frequency:** nominal 13 kHz, quartz crystal timing reference

**Basic Sensitivity:** 5 x 10<sup>9</sup> root Hertz (detectivity)

**Lag Coefficient:** 70 milliseconds

**Reactive Overload:** approximately 10,000 micro-cgs units (volume susceptibility)

**Resistive Overload:** approximately 1,200 micro-cgs units (volume susceptibility)

**Ground Cancellation Range:** From ferrite to salt, inclusive

**Discrimination Ground Suppression:** combination of second and third order methods

**ID Ground Suppression:** third order

**Battery Life:** typically 40 hours with good quality alkaline, somewhat less with NiMH rechargeable.

**Operating Temp Range:** -4 to +122 degrees F (-20 to +50 degrees C)

**Operating Humidity Range:** 0-90% non-condensing

# CONTROLS

## **ON-OFF & VOLUME Knob** (Under the elbow)

This knob turns the machine on or off, and controls speaker volume and headphone volume. *Knob position has no effect on detector's sensitivity or susceptibility to noise from electrical interference*

The **T<sup>2</sup>** has two controls on the front panel, MENU and SETTINGS.

## **MENU Pushbutton** (On right of the front panel)

Push the MENU button to:

1. Step through the menu selections on the display.  
With each push of the button, the next menu selection will be highlighted.  
The SETTINGS knob allows you to change the values of the highlighted selection.
2. Recall the last setting which you adjusted.  
After you have adjusted a setting, an arrow will remain highlighted next to this menu selection. One push of the menu button will recall that selection and display the stored value.

This recall function is useful for a value you want to adjust frequently, such as the ground cancellation value.

## **SETTINGS Knob** (On the left of the front panel)

Rotate the SETTINGS knob to:

1. Change the setting (or value) of the highlighted menu selection you have chosen.
2. Select operating MODE when the top line of the menu is highlighted.  
When used to switch back and forth between the All Metal Mode and Discrimination Mode, the detector changes modes as soon as the corresponding selection is highlighted. The All Metal Mode is used to detect all metal objects, including small or deep objects. Use the Discrimination Mode to ignore trash metal such as nails, foil, or pull-tabs.
3. Recall the last setting which you adjusted.  
When you rotate the settings knob, you are also changing the value. If using this knob to recall a setting, it is best to rotate just one indent.

## **TRIGGER SWITCH** (Under the control housing in front of your hand)

While the trigger is **pulled** back, metal objects are temporarily detected without the need for

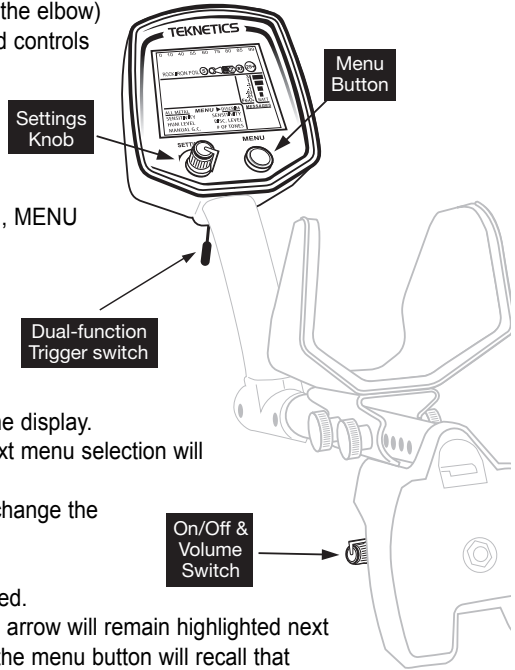

## Controls (continued)

searchcoil motion. This aids in pinpointing the exact location of objects which were found while searching in the All Metal or Discrimination Mode.

When the trigger is **pushed** forward, FASTGRAB™ automatic ground cancellation is activated. The internal computer measures the magnetic properties of the soil in order to cancel interference from naturally-occurring minerals in the ground. After the detector measures the soil in this manner, the detector then uses this information to control operation in both the All Metal and Discrimination search modes.

## THE MENU SYSTEM

The entire menu is printed on the LCD display. The display highlights the mode and settings which are in use.

There are two search modes, All Metal and Discrimination. To change between search modes, the top line of the menu system must be highlighted. Press the MENU button until the top line of the menu is highlighted. When either **ALL METAL** or **DISCRIM** is highlighted, rotate the SETTINGS knob to change between the two modes.

Mode-Toggle: to quickly toggle between the two modes, press-and-hold the MENU button for one second. Use this Mode-Toggle function to quickly change between the two modes, regardless of where you are positioned in the menu. The menu will be inactive after toggling between modes, so to use the menu after toggling, press the MENU button again to activate.

Each search mode has three adjustable function settings:

**ALL METAL:** Sensitivity, Hum Level, and Manual Ground Cancellation. See page 15.

**DISCRIMINATION:** Sensitivity, Discrimination Level, and Number of Tones. See page 16-17.

To select a function, push the MENU button and continue pushing to move to the function you want. The word **SETTING** will pop up on the display above the menu, and the present setting of that function will be displayed as a number.

To change a setting, rotate the knob.

To increase a value, rotate to the right (clockwise)

To decrease a value, rotate to the left (counterclockwise)

If you select a function and do not make a change to that function after 5 seconds, the detector will exit the menu system automatically, and resume normal operation.

If you press the MENU button or rotate the SETTINGS knob while the machine is in normal operation, the user interface will return to the last menu feature setting. This feature allows you to have quick access to a function that you want to adjust frequently.

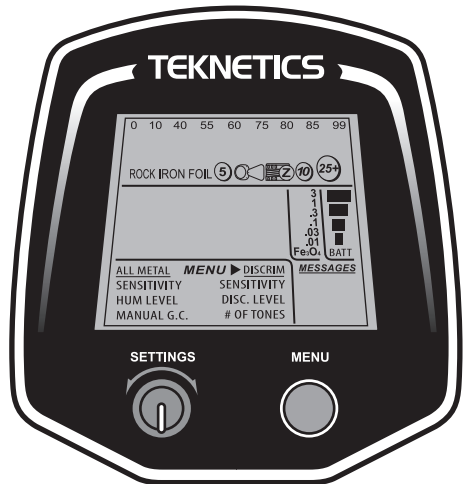

# GROUND CANCELLATION

## What is Ground Cancellation?

All soils contain minerals. Signals from ground minerals are often tens or hundreds of times as strong as the signal from a buried metal object. The magnetism of iron minerals, found in nearly all soils, causes one type of interfering signal. Dissolved mineral salts, found in some soils, are electrically conductive, causing another type of interfering signal.

Ground Cancellation is the process by which the metal detector cancels the unwanted ground signals while leaving signals from buried metal objects intact. This is accomplished by establishing the detector's internal Ground Phase setting; this setting is calibrated to the soil and eliminates the ground minerals' signal.

When the detector is calibrated to the actual soil condition, the result will be deeper target detection, quieter operation, and more accurate target identification. This calibration, or Ground Cancellation, can be accomplished automatically with the detector's internal computer, by pushing the Trigger Switch forward, or manually in the All Metal menu.

The ground cancellation setting carries through into both All Metal and Discrimination Modes. In Discrimination Mode, the ground signal is generally inaudible unless the discrimination setting is 0.

## AUTOMATIC GROUND CANCELLATION PROCEDURE (FASTGRAB™)

1. Find a spot of ground where there is no metal present.
2. Hold the detector with the searchcoil about one foot above the ground.
3. Push the TRIGGER SWITCH forward with your index finger.
4. Physically pump the searchcoil and detector up and down over the ground. Lift it about 6-inches above the ground and lower it to within 1 inch of the ground, about once or twice a second.
5. A 2-digit value will appear on the display. This is the Ground Phase setting.

*If the detector's internal computer is unable to cancel the ground signal, the message **CAN'T GC** will appear; find another spot of ground and try again.*

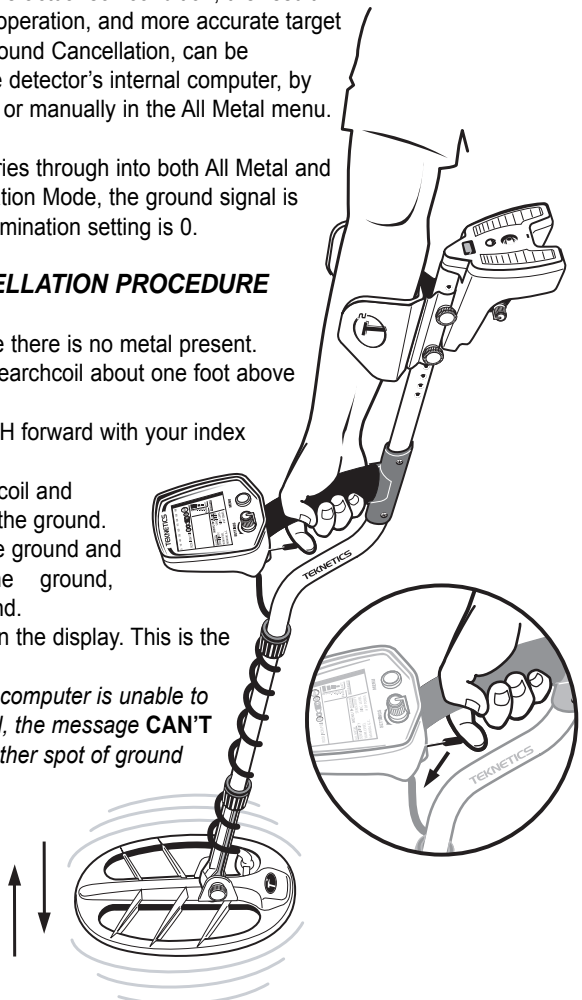

## GROUND CANCELLATION (continued)

### MANUAL GROUND CANCELLATION

In most situations, it is preferable to push the trigger switch to activate FASTGRAB™ automatic ground cancellation. Generally, it is best to first let the computer automatically cancel interference from ground minerals. However, for gold prospecting, searching on a wet saltwater beach, or searching in an area with so much metal trash that there is no *clean* ground for the computer to sample, we recommend that you cancel ground manually. Manual ground cancellation requires a bit of skill, acquired with some practice.

The range of ground cancellation settings indicated on the display range from 0 to 99; however, each displayed number spans 5 detent steps on the settings knob. The actual internal ground cancellation setting changes with each step; there are a total of 500 different settings. Under some ground conditions you may be able to hear the individual steps in the setting.

The  $\text{Fe}_3\text{O}_4$  bar graph on the LCD display indicates the *amount* of magnetic mineralization. The searchcoil must be in motion to measure  $\text{Fe}_3\text{O}_4$ . The most accurate measurement is obtained by *pumping* the searchcoil, as in the Ground Cancellation procedure.

The two-digit G.C. Phase number displayed on the LCD indicates the *type* of ground mineralization.

Some typical ground mineralization types are:

- |    |   |    |   |
|----|---|----|---|
| 0  | – | 10 | Wet salt and alkali   |
| 5  | – | 25 | Metallic iron (very few soils in this range. You may be balancing over metal) |
| 26 | – | 39 | Very few soils in this range — occasionally some saltwater beaches            |
| 40 | – | 75 | Red, yellow, and brown iron-bearing clay minerals                             |
| 75 | – | 95 | Magnetite and other black iron minerals                                       |

When manually ground canceling, try to “feel out” a spot on the ground to make sure there is no metal present. In order to avoid locking onto metal, the computer will not cancel ground where the numbers are less than 40. Where the ground reads less than 40, manual ground cancellation is required.

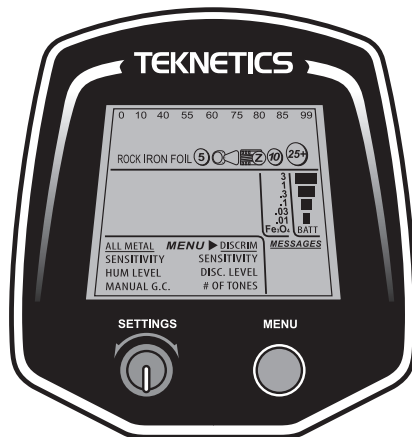

## **GROUND CANCELLATION (continued)**

---

### **MANUAL GROUND CANCELLATION (continued)**

To perform the Manual Ground Cancellation operation, do the following:

1. Select the **MANUAL G.C.** function  
The legend **G.C. PHASE** appears.  
The present ground cancellation setting is displayed (0-99).  
The message **PUMP COIL TO G.C.** will appear.
2. Physically *pump* the searchcoil and detector up and down over the ground.  
Lift it about 6-inches above the ground and lower it to within 1 inch of the ground, about once or twice a second.
3. Turn the SETTINGS KNOB to adjust the level.  
The goal is to eliminate the sound as the coil is being pumped over the ground. In some soils, the sound is not completely eliminated; rather, the audio feedback is the same both when lowering the searchcoil to the ground, and when lifting the searchcoil off of the ground.

If the ground cancellation adjustment is incorrect, there will be a difference in the sound as the searchcoil is either moving toward or away from the ground. It sounds like you are either ***pulling the sound out of the ground, or pushing the sound into the ground.***

- If the sound is louder as you raise the searchcoil, increase the ground cancellation setting.
- If the sound is louder as you lower the searchcoil, reduce the ground cancellation setting.

**NOTE:** Experienced users often prefer to adjust the ground cancellation to get a weak but audible response when lowering the searchcoil. This is called adjusting for positive response.

### **Positive and Negative Response**

The purpose of ground cancellation is to adjust the metal detector to ignore ground minerals. If the adjustment setting is off, ground minerals will give either a *positive* or *negative* response, depending on which direction the adjustment is off.

#### **POSITIVE RESPONSE**

If the G.C. setting is too high a number, the response of minerals will be *positive*. This means that when the searchcoil is lowered to the ground in PinPoint or All Metals Mode, the sound will get louder as the searchcoil approaches the ground. The sound will grow quieter as the searchcoil is raised. What, if anything, you hear in Discrimination Mode depends on the discrimination setting.

When searching in All Metals Mode, if ground cancellation is properly set to cancel the ground, and you sweep over a *positive hot rock*, the rock will give a “zip” sound similar to that of a metal object.

#### **NEGATIVE RESPONSE**

If the G.C. setting is too low a number, the response of minerals will be *negative*. When the searchcoil is lowered to the ground in PinPoint or in All Metals Mode, the machine will be silent. In All Metals Mode, the machine will sound off as the searchcoil is lifted away from the ground. What you hear, or do not hear, in Discrimination Mode will depend on the discrimination setting.

When searching in All Metals Mode, a *negative hot rock* will produce a “boing” sound after passing over it, making it difficult to tell where it is located. It will not have the sound and “feel” of a metal object.

## ***ALL METAL MODE***

---

The All Metal Mode is more sensitive and offers better *feel* than the Discrimination Mode, and is used to find all metal objects present in the ground. The searchcoil must be in motion for objects to be detected. This is a single filter search mode similar to the “fast autotune”, “SAT”, or “P4” Mode found in other detectors you might already be familiar with.

**SENSITIVITY** This controls the *electronic gain*, and is adjustable from 1 to 99. In the presence of electrical interference, high ground mineralization, or variable ground mineralization, operation will usually be too noisy (wobbly and erratic sound from the speaker) if the sensitivity is set too high. At settings above 90, the internal circuit noise of the machine will probably be audible. The sensitivity level setting is largely a matter of personal preference. However, if you cannot hear at least some noise, the smallest or deepest objects will not be detected.

**HUM LEVEL** This is the same thing that some manufacturers call *audio threshold*. It is adjustable from -9 to +9. For maximum ability to hear the weakest signals, adjust this background hum level high enough so that it is barely audible while the detector is in use in the field. To eliminate the weakest signals, adjust the hum level into the negative region, which will allow the machine to run silently if the Sensitivity is not set too high.

The hum level changes slightly with each detent step on the **Settings** knob. Each number on the hum level numeric readout corresponds to five steps.

### ***MANUAL GROUND CANCELLATION***

Manual Ground Cancellation can only be performed while in the All Metal Mode, but the resultant setting will carry over if you change into Discrimination Mode. See the previous section on Ground Cancellation for instructions on how to use this feature.

# **DISCRIMINATION MODE**

---

The Discrimination Mode is used to eliminate from detection trash metal objects such as nails, aluminum foil, or pull-tabs. The searchcoil must be in motion for metal objects to be detected. Discrimination incurs some loss of sensitivity to small or deep objects.

## **SENSITIVITY**

This controls the *electronic gain*, and is adjustable from 1 to 99. Unlike the All Metal Mode, the Discrimination Mode is designed to operate silently. If you hear noise when there is no metal present or when the searchcoil is not in motion, reduce the Sensitivity setting until the machine goes quiet.

**NOTE:** there is no interaction between the sensitivity settings of the All Metal and Discrimination Modes.

## **DISCRIMINATION LEVEL**

This is adjustable from 0 to 80, and controls the range of objects to be eliminated from detection (silenced, discriminated out or rejected). Objects with numeric values below the selected discrimination level will not be detected. **NOTE:** the numerical range that pertains to each class of object is printed at the top of the visual display. To eliminate iron, a setting of 40 is usually about right. A setting of 80 will eliminate aluminum trash and zinc pennies, but nickels will also be lost.

## **NUMBER OF TONES (# OF TONES)**

This menu selection offers the user a choice among several *different methods of audio discrimination* to accommodate a variety of search conditions and personal preferences. These methods differ in the way the signals are processed for analysis, and in the number of audio tones used to identify different target types.

The detector has two ways of processing signals for analysis — continuous and sampled.

### **Continuous Processing**

The detector processes a continuous signal response throughout the duration of the sweep of the searchcoil over the target. All characteristics of the target are audibly communicated to the user. Continuous processing gives a good *feel* for the size, depth, and shape of the target. Continuous processing is preferred, for example, for relic hunting, especially in plowed or rocky ground.

### **Sampled Processing**

Sampling takes a *snapshot* of the signal at its strongest point. This compromises the *feel* of a continuous response, but provides for more accurate target identification. Sampling also eliminates confusion caused by changes in tones during the sweep over the target. Sampling is preferred, for example, when coinshooting in areas where there is aluminum trash.

The “# OF TONES” selections are:

#### **1: Single Medium pitch tone.**

Discrimination is continuous, not sampled. Good for use in plowed or rocky ground.

#### **1+: Medium-to-High pitch tone varying in proportion to target signal strength.**

Large shallow objects will produce a squeal. The variable audio pitch provides you more information about the detected object, but some people find the sound on strong signals too annoying. Good for use in plowed or rocky ground.



## DISCRIMINATION MODE (continued)

### 2+: Two tones.

Similar to 1+, except that iron produces a low-pitched tone regardless signal strength. The discriminator is continuous. However, the iron tone feature relies on a combination of continuous and sampled processing. Useful if you want to hear all targets.

**3: Three different audio tones.** Iron produces a low pitched tone. Aluminum trash and zinc pennies produce a medium tone. Most other coins, including nickels, produce a high tone. A combination of continuous and sampled processing reduces the *breaking up* of the tone due to deep objects, or multiple objects close together. This method is

usually preferred if you are searching for coins in a trashy area. Most users will set the discrimination level below nickels, at about 50, and dig only objects that produce a consistent and repeatable high tone. **NOTE:** with this method, some steel bottle caps produce consistent high tones, similar to coins (see section on bottle cap identification).

**3b: Bottle Cap Mode** Similar to 3, but modified so that steel bottle caps will usually produce inconsistent, or non-repeatable, tones and broken sounds. There may be a slight reduction in the ability to separate adjacent targets. Use this method in areas with a high concentration of steel bottle caps. Also refer to p. 25 for sweep techniques to aid in the identification of steel bottle caps.

**4: Four different audio tones** This method is similar to 3, but with a fourth medium-high tone for targets in the numeric range of 73 to 79. This four-tone system is useful for searching in areas where there may be very old coins which register in this range.

**dP: Delta Pitch** This method produces a tone whose pitch varies in relation to the visual ID number — the higher the ID, the higher the pitch. Good for relic hunting. Sampling is mostly continuous. This method is also useful in areas with a high concentration of steel bottle caps. Coins will produce a fairly constant pitch as you sweep back and forth. Bottle caps produce inconsistent tones, often with a *squawk* at the beginning of the sound.

### What You See vs. What You Hear

The visual Target-ID displayed on the LCD is based entirely on sampled processing; the number displayed represents the *snapshot*. When using these different “# OF TONES” methods, the detector’s audible response may differ from the visual. Using these methods, there is not a 100% correspondence between what you see and what you hear, especially on buried targets where ground minerals influence Target-ID and audible response. By making the audio and visual systems independent, the **T** allows each system to do what it does best. The audio is optimized for quick response and target feel, whereas the visual system provides the best numeric resolution of Target-ID.

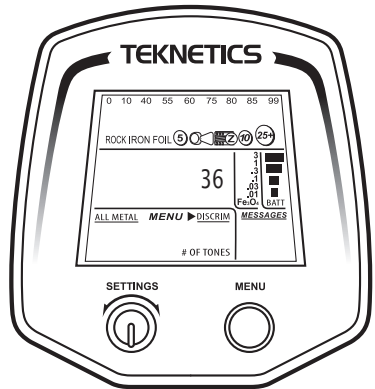

## ***PinPoint Feature***

---

After a buried target has been located using the All Metal or Discrimination Modes, you want to pinpoint the exact location of the target in order to facilitate its recovery. Accurate target pinpointing will minimize digging.

Activate the PinPoint feature by pulling the trigger switch located under the housing, in front of the grip. Unlike the All Metal and Discrimination Modes, PinPoint does not require motion to detect metal. PinPoint will detect objects while the coil is in motion and will continue to detect metal if searchcoil motion stops over the target.

### ***Ground Pick-Up***

If you have not performed the ground cancellation procedure, the PinPoint feature usually causes the ground to sound off. This means that while pulling the pinpoint trigger, the audio tone will get louder as you lower the searchcoil to the ground; this is called ground pick-up. Since you want to hear the target, rather than the ground, we recommend first ground canceling in order to eliminate *ground pick-up*. Alternatively, if you experience ground pick-up, you may place the coil very close to the ground, off to the side of the target; then pull the trigger, and raise the searchcoil slightly while passing it over the target.

### ***How to Pinpoint***

Position the searchcoil just barely off the ground, and to the side of the target. Then pull the trigger, and raise the searchcoil about 2-inches. Lifting the searchcoil away from the ground causes the ground signal to go negative; the machine becomes silent. Now move the searchcoil slowly across the target, and the sound will communicate the target's location. As you sweep from side to side, and hear no sound at the ends of the sweep, the target is located in the middle of that zone, where the sound is loudest and the audio pitch is highest. If the sound is loud over a wide area, the buried object is large. Use the PinPoint feature to trace an outline of such large objects.

### ***Narrow It Down***

To further narrow the field of detection, position the searchcoil near the center of the response pattern (but not at the exact center), release the trigger, and then pull it again. Now you will only hear a response when the searchcoil is right over the top of the target. Repeat this procedure to narrow the zone even further. Each time you repeat the procedure, the field of detection will narrow further.

### ***Controlling Sensitivity in PinPoint Mode***

The default sensitivity setting in PinPoint is 60. If you wish to change the PinPoint sensitivity setting:

Pull the trigger to engage PinPoint. Do not release the trigger.

Rotate the SETTINGS knob to change the sensitivity.

Rotate counterclockwise to decrease sensitivity; clockwise to increase.

Adjustment to PinPoint sensitivity will not affect sensitivity of the All Metal or Discrimination Modes. Likewise, sensitivity changes in the other modes will not affect Pinpoint. Changes to pinpoint sensitivity will be saved after the trigger is released. When the **T** is powered off, the device will revert to the default setting.

## LCD VISUAL DISPLAY

In normal operation, when the searchcoil passes over a metal object, the electrical signature (2-digit ID) of the metal object is displayed on the numeric display for 4 seconds, unless superseded by another object sooner. On a given buried object, the number will bounce around if the signal is weak or if the amount of ground mineralization is high.

At the top of the display, an arrow indicates the classification of the object.

### NUMERIC TARGET-ID (2-digits)

The following table shows the numbers typically associated with certain commonly encountered nonferrous metal objects. Older silver U.S. coins usually read about the same as their modern clad equivalents. Modern quarter-sized dollar coins like the Susan B. Anthony and the Sacagawea read about the same as a quarter. Many Canadian coins are minted from a magnetic nickel alloy which gives very inconsistent readings and may register as iron. Most one-ounce silver bullion coins will fall into the same range as the modern U.S. \$1 Eagle.

#### OBJECT

foil from gum wrapper  
U.S. nickel (5¢ coin)  
aluminum pull-tab  
aluminum screwcap  
zinc penny (dated after 1982)  
aluminum soda pop can  
copper penny, clad dime  
U.S. quarter (25¢ coin), clad  
50¢ coin, modern clad  
old silver dollar coin  
US silver Eagle \$1 coin

#### TARGET-ID

40 - 55  
typically 58  
60 - 75  
70 - 80  
typically 78  
75 - 85  
typically 83  
typically 89  
typically 92  
typically 94  
typically 95

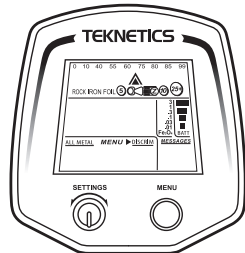

STRONG MEDIUM WEAK

### PROBABLE TARGET-ID

The probable Target-ID zones at the top of the LCD display represent the signal ranges produced by various coins and types of metal objects. When a metal target is detected, the microcomputer analyzes the signal and categorizes it based on what kinds of metal objects usually produce that kind of signal. The microprocessor then displays an arrow along the top of the LCD screen above the icon which represents that category.

For instance, if the detected signal fits within the parameters usually exhibited by zinc pennies and the electrically similar aluminum screwcaps, the microcomputer will categorize the signal as “zinc penny/aluminum screwcap”. The LCD screen will then illuminate the arrow above the zinc/screwcap icon.

Copper pennies (pre-1982) will usually register in the 10¢ zone.

Most gold jewelry is small, and will tend to read in the 40-60 range. Silver jewelry usually has more metal in it and therefore tends to produce higher readings.

Since different metal objects can produce similar signals, and since minerals in the soil can distort the signals, the probable Target-ID's are just that — probable. There is no way of knowing for sure what's buried other than to dig it up. Experienced metal detector users have a rule of thumb — “when in doubt, dig”.

## LCD VISUAL DISPLAY (continued)

The target indicator arrows are coded for signal strength — bold arrow for strong signals, caret (Λ) arrow for medium signals, and small triangle for weak signals. When sweeping back and forth to check a target, the indications corresponding to the strongest signals will usually be the most accurate.

### TARGET DEPTH

When the trigger is pulled to facilitate pinpointing an object, the numerical display indicates the approximate depth of the object, in inches, based on the assumption that the object is a typical US coin. Small objects will read deeper than they actually are, and large objects will usually read shallower than they actually are.

### G.C. PHASE

This is the ground cancellation setting, 0-99. It is displayed when in the Manual G.C. menu setting, and when the trigger is pushed for FASTGRAB™ computer-assisted ground cancellation.

### SETTING

This is illuminated when you are in the menu. When the word “SETTING” is indicated, the number being displayed is a setting, and not, for instance, a Target-ID indication.

### MESSAGES

If a metal object or highly magnetic soil is so close to the searchcoil that the signal is overloading the circuit, the message **OVERLOAD - RAISE COIL** will appear. Such overloads will not harm the detector, but the detector will not detect metals properly under these conditions. Raise the coil until the message disappears; the siren sound will also stop. Resume normal detection.

The message **RAISE COIL** only appears when using the 3b or dP methods, accessed through # OF TONES menu selection. This message indicates the presence of a target which may be too close to the searchcoil to be accurately identified. For better target identification, sweep the searchcoil farther away from the surface of the ground.

The message **PUMP COIL TO GC** will appear when you push the trigger forward to ground cancel. See the Manual Ground Cancellation section of this manual for instructions.

The message **CAN'T GC** can only appear when the trigger is pushed forward, invoking FASTGRAB™ automatic ground cancellation. This message appears when the detector is unable to measure the soil in a manner suitable for ground canceling. This message is usually the result of the presence of metal. Try another spot to find an area free of metal.

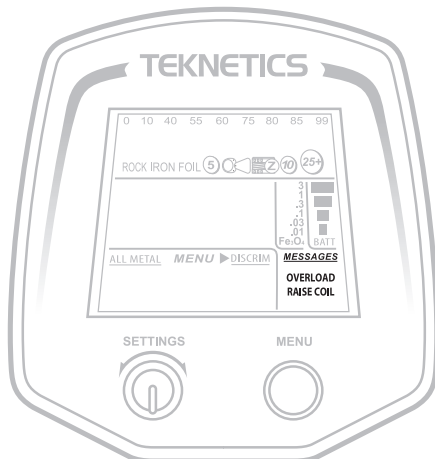

## LCD VISUAL DISPLAY (continued)

### BAR GRAPHS $Fe_3O_4$ (magnetite)

This bar graph displays the magnetic mineralization factor, or magnetic susceptibility, of the soil. Magnetic susceptibility is expressed in terms of the percent volume of the iron mineral magnetite, which most black sand is made of. The depth to which objects can be accurately identified is strongly influenced by the magnetic susceptibility of the soil. High  $Fe_3O_4$  values have a greater effect on detection depth in the Discrimination Mode than in the All Metal Mode. For the most accurate  $Fe_3O_4$  reading, pump the searchcoil as though you were ground canceling.

$Fe_3O_4$ Range	approx. micro-cgs	Description
3	7,500	uncommon but not rare, heavy mineralization
1	2,500	heavy mineralization, not uncommon in goldfields
0.3	750	heavy mineralization, but not uncommon in some regions
0.1	250	medium mineralization, typical
0.03	75	light mineralization, but common
0.01	25	light mineralization, often low G.C. setting
blank	<14	quartz & coral white beach sands

### BATTERY CONDITION INDICATOR

Fresh alkaline batteries will illuminate all four bars. When no bars are displayed and the batteries are about to go dead, the **BATT** legend will start flashing. If using NiMH rechargeable batteries, the display will remain stuck on the second or third bar for most of the battery life; when it drops to the first bar, the batteries will go dead within several minutes.

## FREQUENCY SHIFTING

One disadvantage of a highly sensitive metal detector is its susceptibility to electrical interference from other electronic devices. If the detector chatters while the searchcoil is not in motion, the cause is either electrical interference or internal circuit noise due to a high sensitivity setting. If the detector chatters or emits intermittent false signals in the field, you are also probably experiencing electrical interference. If you suspect electrical interference, you may change the **T<sup>2</sup>'s** operating frequency. This is a trial and error method to try to find a frequency different from the suspected source.

To shift frequencies:

1. Hold the MENU button down. Do not release the button.
2. Push the trigger forward to increase the frequency  
Or pull the trigger back to decrease the frequency.

Each frequency change requires a push of the MENU button.

Each actuation will shift the frequency by one value.

The LCD will display the frequency, from F1 to F7. The default frequency is F4. The **T<sup>2</sup>** will default back to F4 when the power is switched off.

See page 27 for more information on electrical interference.

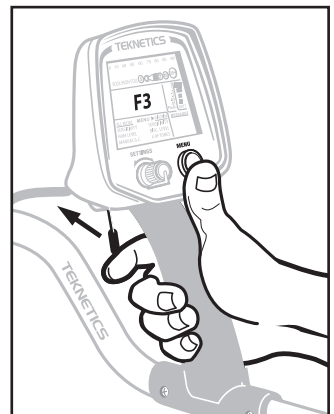

## ***CAPABILITIES AND LIMITATIONS***

---

### ***DEPTH***

The *T<sup>2</sup>* can detect U.S. coins to a depth of about 12-15 inches under good conditions. Large objects (55 gallon drums, manhole covers, etc.) can be detected to a depth of several feet.

Electrical interference from power lines and from electrical appliances and electronic equipment can reduce detection depth, or cause audible interference, making it necessary for the user to reduce the sensitivity setting. Soils with large amounts of iron or salt minerals may also reduce detection depth or necessitate a reduction in the sensitivity setting.

### ***TARGET IDENTIFICATION***

The *T<sup>2</sup>* identifies the probable type of metal object by measuring its effective electrical conductivity, which is displayed as a number from 0 to 99 on the LCD screen. The *effective electrical conductivity* of an object depends on its metallic composition, size, shape, and orientation relative to the searchcoil. Since coins are minted to tightly controlled specifications, they can be accurately identified. Identification of pull-tabs and foil is less consistent because these kinds of targets come in wide variety. In general, smaller objects, and objects made from lower conductivity alloys such as iron, bronze, brass, lead, pewter, and zinc will read lower on the effective conductivity scale. Larger objects and objects made from higher conductivity alloys such as silver, copper, and aluminum, will tend to read higher. The notable exceptions are gold, which usually reads low because it is rarely found in large pieces, and zinc pennies, which read moderately high because of their size and shape. Although nails and other iron and steel objects will usually give low readings, ring-shaped pieces of iron (for instance steel washers and harness rings) will usually produce medium to high readings. Flat pieces of iron or steel, such as can lids, will occasionally do the same.

Most targets can be identified accurately in air to a distance of about 10-inches. The minerals in many soils will cause identification to be less accurate. In most soils, effective target identification can be had to a depth of at least 8-inches.

### ***REQUIREMENT FOR MOTION; PINPOINT FEATURE***

As with other modern metal detectors, the *T<sup>2</sup>*'s searchcoil must be kept in motion in order to both detect and identify targets. The All Metal Mode is more forgiving of sweep speed variation than is the Discrimination Mode.

The trigger-activated PinPoint feature continues to detect metal if searchcoil motion stops over the target. The PinPoint feature is used primarily to pinpoint the exact location of a target so that it can be retrieved with a minimum of digging, and does not provide target identification.

## ***CAPABILITIES AND LIMITATIONS (continued)***

---

### **GROUND CANCELING**

To achieve maximum depth in both the ALL METAL and DISCRIMINATION Modes, as well as when using the PinPoint feature, the **T<sup>2</sup>** offers the ability to cancel ground minerals either by manual adjustment, or automatically using the FASTGRAB™ feature (see p.12).

If you do not perform the ground canceling operation, the Discrimination Mode will usually still work fairly well, but the ALL METAL Mode will not. The Pinpoint feature can be used for pinpointing objects at moderate depth in most soils without prior ground-canceling.

The internal computer will not automatically cancel salt water, so when detecting on wet ocean beaches, ground cancellation must be done manually.

### **DISCRIMINATION**

Discrimination refers to a metal detector's ability to ignore metal objects in selected categories, especially iron and aluminum. This makes searching much more pleasant in an area with a lot of metal trash. The **T<sup>2</sup>** offers a wide variety of discrimination features which you can select according to the search conditions and your personal preference.

### **DEPTH READING**

The estimated Depth Reading displayed when engaging the PinPoint feature is based on the strength of the signal. It is calibrated for typical coin-sized objects. Small objects will read deeper than they actually are, and large objects will read shallower than they actually are.

### **AIR TESTING**

There may be times when you want to test or demonstrate the metal detector without sweeping it over the ground, for instance, if not fully assembled, or if you are indoors. To air test, place the searchcoil in a spot where the detector is stable and more than two feet away from any large masses of metal, including the reinforcing steel usually present in concrete. If you are wearing a wristwatch or jewelry on your hand or arm, remove it. Then, test or demonstrate by waving metal objects over the searchcoil; wave objects briskly, several inches over the top of, and parallel to, the searchcoil.

Ground cancellation cannot be tested or demonstrated in air unless you happen to have appropriate specimens of iron minerals available.

### **SWEEP SPEED**

The **T<sup>2</sup>** is noted for its quick response. This gives it unsurpassed ability to locate and identify good targets surrounded by trash. It also permits the user to sweep the searchcoil quickly in order to cover more ground with very little risk of losing targets. In general, if you are searching an area where the desirable targets are more than 8 to 10-inches deep, a faster sweep speed will detect to a greater depth and yield more accurate Target-IDs.

### **CHECKING A TARGET**

In order to most accurately verify a detected target with most other metal detectors, users will narrow their sweep and loiter over the top of the target. The **T<sup>2</sup>** is different. The **T<sup>2</sup>**'s quick response and advanced signal sampling system produces the most accurate Target-IDs with deliberate (shoulder width) sweeps all the way across the target, even if there are other targets nearby. If you use a non-standard sweep method or speed to check targets with the **T<sup>2</sup>**, the ID's will bounce around more and you run the risk of misidentifying the target.

## **CAPABILITIES AND LIMITATIONS (continued)**

### **STEEL BOTTLE CAPS & FLAT IRON TRASH**

Modern motion-type Target-ID metal detectors usually have difficulty consistently identifying steel bottle caps and other flat iron trash objects. Double-D searchcoils also have a reputation for being unable to distinguish steel bottle caps from coins, and for being unable to eliminate steel bottle caps from detection. If you are searching in an area where there are many steel bottle caps or other flat iron trash targets, minimize the amount of unnecessary digging with the following methods:

**1. Search with the 3b (bottle cap) method** using the # OF TONES feature. This method calculates visual ID differently in order to cause steel bottle caps to read lower on the scale, and to register less consistently. A desirable object such as a coin will usually produce numeric values that are fairly consistent in both directions of sweep. See # OF TONES under the DISCRIMINATION Mode section of this manual.

**2. Search in dP Mode.** This method calculates visual ID differently in order to cause steel bottle caps to ID lower on the scale and to register less consistently. It also produces more audio clues to the character of the target.

**3. Lift the searchcoil or sweep at an angle.** Within 2-inches of a Bi-Axial searchcoil, the crossed magnetic fields of the Double-D construction can produce anomalous responses. If the object feels shallow (strong signal, narrow response, or multiple responses in a single sweep) and is giving consistent high readings like a coin, raise the searchcoil 2 to 3 inches and try again. A coin will almost always continue to give consistent readings unless it is right next to an iron object. **A steel bottle cap that is at least 3-inches away from the searchcoil will usually produce readings that bounce around from medium to low numbers.**

**4. Sweep REAR of coil over the target or sweep fast**

1. If the ID# is repeatable around 81 to 84, when passing over center of searchcoil at normal speed, then target should be a dime or copper penny.
2. If not in the range of 81 to 84, then:
  - a. Sweep the back end of searchcoil over the target. If tones change from high to a low tone, it is probably a bottle cap.
  - b. Sweep center of searchcoil fast across target.
    - i. If tone and ID-value drop, it is probably a bottle cap.
    - ii. If a bottle cap, the faster you sweep, the lower the tone.

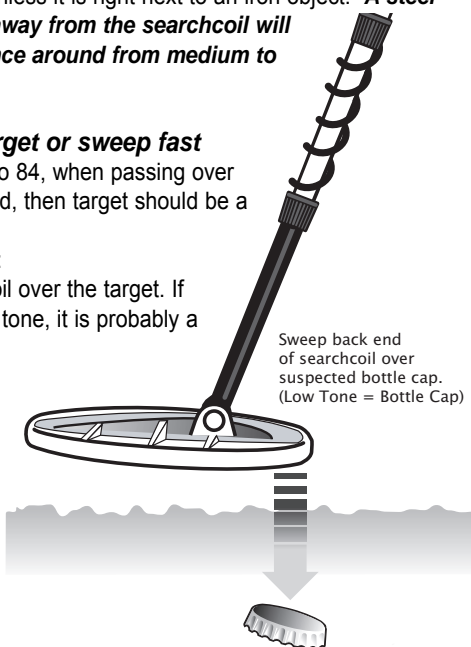



## **SEARCH TECHNIQUES**

**Sweeping Searchcoil** (this does not apply to Pinpointing with the trigger switch) Keep the searchcoil in motion to detect targets. Sweep the searchcoil parallel to the ground; do not lift the searchcoil at the end of the sweep.

When you have located a target and continue sweeping back and forth for verification, use broad, deliberate sweeps across the target for the most accurate Target-ID. Do not use short sweeps as you might with other metal detectors.

### **Shallow Targets**

Shallow targets tend to give multiple responses, with the last response being the one that remains illuminated on the visual display. This last response is usually sampled at the edge of the searchcoil and will tend to be inaccurate. If you suspect a shallow target (within 2 to 3 inches of the searchcoil), lift the searchcoil slightly, and slow down your sweep speed until you notice a single response consistently in the same place.

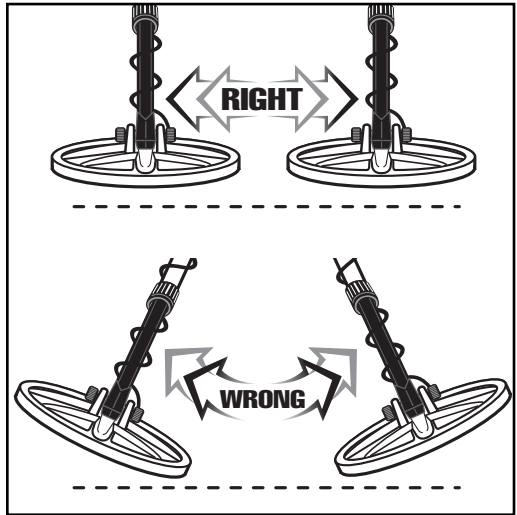

Large shallow targets will cause signal overload, indicated by the siren sound. In these instances, raise the searchcoil until the overload warning disappears, and sweep at this increased height.

### **Large Targets**

If an overload warning is not confined to a small spot, you are probably overloading on a large object, for example, a large iron pipe, reinforcing steel in concrete, or buried sheet metal. It is usually not possible to locate objects, such as coins, in close proximity to large masses of metal.

### **Pinpointing With the Trigger Switch**

When you turn the **T** on, the ground cancellation setting is preset to give a positive response on nearly all soils. This means that if you are pulling the pinpoint trigger, the audio tone will get louder as you lower the searchcoil to the ground. But you do not want to hear the ground; you just want to hear the target. So always Ground Cancel first.

After you have discovered a buried metal target using the ALL METAL or DISCRIMINATION Modes, use the trigger switch to pinpoint its exact location.

Position the searchcoil an inch or two (2.5-5cm) above the ground, and to the side of the target. Then pull the trigger. Now move the searchcoil slowly across the target, and the sound will communicate the target's location. As you sweep from side to side, and hear no sound at the ends of the sweep, the target is located in the middle of that zone, where the sound is loudest and the audio pitch is highest. If the sound is loud over a wide area, the buried object is large. Use the PinPoint feature to trace an outline of such large objects.

## **SEARCH TECHNIQUES (continued)**

---

### ***Narrow It Down***

To narrow the response further, position the searchcoil near the center of the response pattern, release the trigger, and then pull it again. Now you will only hear a response when the searchcoil is right over the top of the target. Repeat this procedure to narrow the zone even further. Each time you repeat the procedure, the field of detection will narrow further.

## ***Estimating Target SIZE, DEPTH, and SHAPE***

When the trigger is pulled to activate Pinpoint, the LCD displays estimated depth. The estimate is based on the presumption that it is a coin-sized target.

But what if it is not a coin-sized target? The most common example is that of an aluminum can. Flattened aluminum cans are usually identified as dimes or quarters. Their large size will produce a strong signal, tricking the microcomputer into thinking that it is a shallow coin.

The following technique differentiates buried aluminum cans from coins. Sweep back and forth to get a feel for the target, keeping the searchcoil close to the ground. Now, continue to sweep back and forth as you slowly raise the searchcoil higher and higher. If the response diminishes quickly and never gets very broad, the target is probably a coin. If the response diminishes slowly as you lift the searchcoil, and you get a broad response, the target is probably an aluminum can. Practice this by laying a coin and a flattened aluminum can on the ground; you will quickly understand how to differentiate the two and will probably never have to dig another aluminum can again. And, you will know whether it was deep or shallow. This technique works well in the All Metal Mode, and to a lesser extent in Discrimination Mode.

Objects which are ring-shaped, or flat and round like coins, tend to give a narrower, crisper response than objects of similar size with irregular shapes. The easiest way to demonstrate this is with an aluminum screwcap from a soda bottle. In its normal shape, it occupies a volume, and gives a somewhat broader response than that of a coin. But if you flatten it, the response will be crisper and more like that of a coin. Again, these differences are most readily noticed in All Metal Mode.

Long skinny iron or steel objects such as nails usually produce a double response when scanned lengthwise, and a weaker single response when scanned crossways. This is most noticeable in the All Metal Mode. However, a coin lying on its edge can produce a similar response, so rely on both the Target-ID as well as *target feel* to distinguish between different kinds of objects. Objects within 2 to 3 inches of the searchcoil will often produce multiple responses as you sweep across them, because the response field close to the searchcoil is irregular.

## **SEARCH TECHNIQUES (continued)**

---

### *Estimating Target-ID*

With a single sweep over a target, you will usually see a 2-digit Target-ID displayed on the LCD. Repeated sweeps back and forth over the target may cause the 2-digit Target-ID values to change with each sweep of the coil; this may seem inconsistent with your discrimination setting. These variations and inconsistencies provide important clues regarding the identity of the buried object.

Most metal detectors have difficulty properly identifying steel bottle caps, and the  $\mathcal{T}$  is no exception. Steel bottle caps will often read in the coin range, at the high end of the scale. The ID number you receive from a buried coin will usually be consistent regardless of sweep speed or angle. The readings from a steel bottle cap will tend to bounce around a lot more, especially with variations in sweep speed or angle. By paying attention and taking this into account, you can minimize the number of bottle caps you dig.

The visual ID and the discriminator are independent systems which analyze different sets of signals. Therefore what you hear, or do not hear, provides additional information regarding Target-ID. For instance, if discrimination is set at 40, and most sweeps result in no visual Target-ID, the target is most likely iron even though the majority of the ID numbers will be greater than 40.

The  $\mathcal{T}$  has a tendency to *up-average* nonferrous targets in the proximity of iron, indicating ID numbers higher than would be obtained in an air test. This tendency is connected with the  $\mathcal{T}$ 's enhanced *see-through* ability – that is, the ability to find valuable targets in an area where there is a lot of iron trash.

### *False Signals and Chatter*

At times the detector may beep when there is nothing there, or it may seem like there is nothing there. There are five major causes for this: electrical interference, nuisance buried objects, ground minerals, *hot rocks*, and sensitivity set so high that internal circuit noise is audible. The problem can usually be corrected by reducing the sensitivity setting, but sometimes other measures can also be taken.

#### **ELECTRICAL INTERFERENCE**

Electrical Interference can be caused by power lines, appliances, computer equipment, cell phones, fluorescent and vapor type lamps, household light dimmers, other nearby metal detectors, electric fences, radio transmitters, and electrical storms. If you get abnormal noise while holding the searchcoil motionless in the air, the cause is electrical interference or internal circuit noise. By walking around with the metal detector, you can often *follow the signal* and track it back to the offending device; simply turn the device off, or come back at another time when it may be off. If the interference is from power lines, you might try another time of day. Interference on power lines is usually caused by something connected to them which may be idle in the evenings or on weekends. If the interference is from a communications or broadcast transmitting antenna, reducing the sensitivity is usually your only recourse.

The  $\mathcal{T}$  allows you to shift operating frequencies to avoid electrical interference. See the Frequency Shifting section on page 21 for information about this technique.

## **SEARCH TECHNIQUES (continued)**

---

### **NUISANCE BURIED OBJECTS**

In some areas there is a lot of metallic trash which produces weak signals. These could include deeply buried objects, little bits and pieces of rusty iron and corroded foil. These items can be detected, but are difficult to pinpoint due to their depth and small size. When you dig and find nothing, it may seem like the machine is beeping at nothing even though there is actually something there. The best solution is usually to reduce sensitivity.

If searching a very trashy area and unwanted signals are a problem, search with the searchcoil 2-inches away from the ground. Trash objects very close to the searchcoil will sometimes not be completely eliminated, even when the discrimination setting should have eliminated the target.

Metal detectors are designed to see one metal object at a time. Where there are two iron objects near each other, the detector can be fooled into thinking that the gap between them is nonferrous metal. This is a common condition where a wooden building has burned or been torn down, and the site is littered with nails. A signal from a nonferrous metal object such as a coin will usually be repeatable, whereas a false *positive signal* resulting from multiple or oddly shaped iron objects will seem to wander around and even to vanish. Experienced detectorists call these *non-repeating signals* and usually do not bother digging them since nonrepeating signals are almost always trash.

### **GROUND MINERALS**

Conductive mineral salts usually produce broad signals which will not be mistaken for a metallic object. Common causes are concentrations of mineral fertilizer, spots where evaporation has concentrated naturally occurring mineral salts, residue from de-icing salts, and urine from livestock. Unless dry, "cow pies" can sound off like they are metal. Ocean beaches have salt water—that subject is discussed elsewhere in the manual.

In spots where there has been intense fire, such as a campfire site or where a stump was burned during land clearing, the soil minerals may be altered by oxidation so that their ground cancellation setting is lower than that of the surrounding soil. In such cases, search slowly and change the G.C. setting as frequently as necessary.

In some areas, electrically conductive industrial minerals such as smelter coke, slag, and charcoal have been dumped or used as landfill. Individual lumps of these materials can usually be quieted by reducing sensitivity and searching with a discrimination level of at least 50. However, where the ground consists primarily of such materials, you may not be able to search quietly. In that case, do not dig unless a signal is crisp and repeatable.

Electrically conductive natural minerals such as graphite, graphitic slate, or sulfide ore minerals are rarely encountered except when gold prospecting. When gold prospecting, you need to be able to hear everything, and you can expect to dig conductive minerals that turn out not to be gold. In a given locality you may learn to recognize what type of rocks these minerals are found in, and to ignore them if people in the area say that gold is not found in rocks of that type.

## SEARCH TECHNIQUES (continued)

---

### HOT ROCKS

A *hot rock* is a rock which causes the metal detector to sound off because the rock contains iron minerals. They come in two basic types.

*Negative hot rocks* (also called cold rocks) are usually magnetite or contain magnetite, and give a negative response because their ground cancellation phase is a higher number than the soil they are found in. They tend to be dark in color, usually black, and usually heavy. In some cases they will have rust stains. They are usually attracted to a magnet, and for this reason gold prospectors always carry a magnet—the ultimate ferrous/nonferrous discriminator. In All Metal Mode, negative hot rocks produce a *boing* sound rather than the *zip* sound of a metallic target; recognize the difference and you will learn to ignore them.

*Positive hot rocks* are iron-bearing rocks which have been oxidized by natural weathering processes so that their Ground Phase number is a number lower than the soil they are found in. They are often small, right on the surface, sound just like a gold nugget, and are common in many gold prospecting areas. They are usually, but not always, drawn to a magnet. They are most often reddish in color but are often black, brown, or yellow. On relic hunting sites, red clay bricks and rocks which have lined a fireplace or a campfire will often be *hot rocks*. The discriminator will usually eliminate them without difficulty if widely scattered, but if there is a large concentration of them, the discriminator may not quiet them all. In that case, you can revert to the rule of thumb — “don’t dig non-repeatable signals”.

### Using the Sensitivity Control

When the  $T^2$  is first turned on, the Sensitivity is at a medium setting appropriate for most coinshooting. For relic hunting or gold prospecting, higher Sensitivity settings are preferred.

In the event of nuisance detection signals due to electrical interference from electrical power lines, electrical or electronic appliances, or another metal detector, it is usually necessary to reduce the Sensitivity setting to achieve quiet operation. Alternatively, use the Frequency Shift feature described earlier in this manual.

If, while searching, you are constantly getting signals from which you cannot recover metal targets, you may be detecting small or deep targets which are not recoverable using the methods at hand. So, you may do better if you reduce the Sensitivity setting.

## **SEARCH TECHNIQUES (continued)**

---

### *Tips On Ground Canceling*

When the **T** first turns on, the ground cancellation Phase Number is preset to 90. This will give a positive response on nearly all soils. If you search in the Discrimination Mode, you will probably not have to cancel the ground. If you switch to All Metal Mode, ground cancellation will probably be necessary.

You must find a spot of ground which is free of metal to accurately cancel the ground signal. Before you attempt to Ground Cancel, sweep back and forth to see if any metal target is present. Locate what seems to be a clear area and then Ground Cancel. Ground Cancellation may be done automatically by pushing the trigger, or manually if you are in All Metal Mode. After you have ground cancelled, sweep back and forth to see if there is little or no audible response to the soil. This is best done either in All Metal Mode, or in Discrimination Mode with discrimination set to zero. Alternatively, use the PinPoint trigger to check the spot. If there is little or no response, ground cancellation was successful. If there is still substantial response, there may have been metal present where you attempted to ground cancel, so find another promising spot and try again. If you cannot find a spot to successfully ground cancel, it is time to give up. Turn the machine off, turn it on again so the ground balance preset will be restored, and then use the machine without ground canceling.

In most areas, once you have ground cancelled, the ground cancellation setting will remain satisfactory for a long time. However, if the soil has been disturbed by digging or the addition of fill dirt, or if you are in a geologically complex setting such as is commonly encountered in gold prospecting areas, you may have to frequently perform the ground cancellation procedure to accommodate changing soil conditions.

When you ground cancel, the numerical Ground Phase Setting will momentarily appear on the LCD screen. In general, sandy or gravelly soils will tend to read in the 75-95 range, light colored loams and clays will tend to read in the 50-80 range, and red clays will tend to read in the 35-55 range. To express it in other terms, the more highly weathered and oxidized the soil is, the lower the numeric reading will be.

The Fe<sub>3</sub>O<sub>4</sub> bar graph indicates how much iron mineralization is present. For it to work, the searchcoil must remain in motion. The most accurate readings will be achieved by *pumping* the coil as you do when ground canceling. The higher the mineralization, the greater the necessity to ground cancel the detector for the best depth performance.

If you are searching for relics, you can make a map of the soil of the site. Make a grid of the site. Then collect data. Ground Cancel to document mineral *type*; view mineral *amount* on the Fe<sub>3</sub>O<sub>4</sub> bar graph. Then plot the data on the site map and draw isolines. In this way you may be able to locate areas which have been dug, backfilled, or subjected to fire. This information in turn helps to reveal the history of the site.

## **DETECTING ACTIVITIES**

---

### **Coinshooting**

Coinshooting is searching for coins, usually in places like parks, schoolyards, church lawns, and people's yards. In most places where coins are likely to be found, there is also a lot of aluminum trash like pull-tabs and bottle caps, as well as steel bottle caps and often nails. Sometimes there is jewelry present. You will usually search using discrimination to get rid of the iron and the aluminum trash, even though this mode will cause you to miss some of the jewelry.

Much coinshooting is done in lawn areas, where digging holes would cause damage to the grass. We recommend use of an accessory hand-held pinpointer in such cases. Recovering targets is usually done by first accurately pinpointing the target, then carefully cutting a slit in the turf with a knife, and tamping it firmly when you are finished. In these situations, you cannot recover deep targets for fear of damaging the turf, so you can cut down on nuisance signals by reducing the sensitivity.

When searching on private property, first get the permission of the property owner. Most of the public places where one is likely to do coinshooting are city, county, or school district property. There is usually no ordinance prohibiting use of a metal detector as long as you are not causing damage. Sometimes such ordinances do exist. Administrators and security personnel often have the legal authority to prohibit any activity they do not like even if there is no ordinance against it. If there is a metal detecting club in your area, someone will usually know what areas can and cannot be searched.

Be prepared to always put your best foot forward when using a metal detector in a public place. Pick up any trash you recover; put it in a pouch or pocketed apron. This way you can explain that you are performing a public service by helping keep the place free of trash, especially pieces of metal or glass that could endanger a child at play. Be proficient at recovering targets without causing damage to the lawn. Explain that whenever you find jewelry which has personal identification marks, such as a class ring, you make an attempt to determine the owner and to return it. When someone who questions what you are doing understands that you are causing no damage and are actually performing a public service, you will usually be welcome.

### **Relic Hunting**

Relic hunting is searching for historical artifacts. The most common desired objects are battlefield debris, coins, jewelry, harness hardware, metal buttons, trade tokens, metal toys, household items, and tools used by workmen and trades people. The most common unwanted metal is iron (nails, fence wire, rusted cans, etc.), but some iron and steel objects such as weapons may be valuable. If you are at a site where you may encounter unexploded ordinance, use caution.

Most relic hunting locations are in fields, forested areas and vacant lots where digging holes will not damage turf grass, so having a detector with good depth sensitivity is important. Some places are so littered with iron that it is necessary to discriminate out iron in order to be able to search, even though you may miss some potentially valuable artifacts.

## **Relic Hunting** (continued)

Before you go relic hunting, obtain permission from the property owner. If you intend to hunt on public land, check first with the administrator to make sure it's not illegal. Certain kinds of sites, on both public and private land, are protected by law from relic hunting. If there is a metal detecting club in your area, some of the members will probably know what the laws are in that area and which sites are, and are not off, limits.

Relic hunting is most rewarding if you have an avid interest in history. In many cases, the value of a relic is not the object itself, but the story it's a part of - what historians call *context* and archeologists call *provenance*. A few pieces of rusty metal can tell the story of life in a specific place, or that of a specific family or person from hundreds of years ago. They can capture our imagination and help to give context to our lives today.

The value and context of a find can be readily lost without proper documentation and storage. Add finds to your collection with care. Take the trouble to understand the site you are searching and keep track of where you find things. Describe exactly how and where items were found. Consider including a sketch of the site with your finds. Organization techniques might include storing together all finds from the same site. Alternatively, if you have an interest in specific items, like buttons, make a button collection, and within that collection, document the circumstances surrounding each button found. If your finds are mixed together, without categorization or documentation, their context will be lost.

The ground cancellation and  $\text{Fe}_3\text{O}_4$  bar graph features of the  $T^2$  can be used to map the soils of a site. In this way you might determine which areas have been dug, backfilled, or subjected to fire. This information in turn helps to reveal the history of the site.

To find promising sites to hunt, conduct research at your local library, look for clues in old newspapers, and seek information on the internet. Where did buildings used to be? Which have since been torn down? Where did people gather for public events like dances and county fairs? Where did train and stage lines run? Where were the swimming holes? In almost every town there is a historical society and museum of local history. Most museums are grateful for anything they can put on display, and when you dig something you cannot identify, the curator can often identify it for you. If you work closely with the local historical society or museum, landowners will be more willing to grant you permission to search their property.

Some of the most promising sites for relic hunting are places being cleared for development. After the site is built on, whatever is in the ground will become inaccessible. The property owner can often be persuaded that the site should be searched immediately while it is still searchable.

## **Gold Prospecting**

In the United States, gold is found in many places in the western states, Alaska, and in a few localities in the Appalachians. The old saying "Gold is where you find it", means that to find gold, you should look in areas where the yellow metal is known to be present.



## **Gold Prospecting** *(continued)*

To be a successful prospector, learn the geology of the area you are prospecting. Learn what geological processes created the gold, and what geological processes put the gold where it is now. Learn to identify the various rock and mineral types which are typical of that area. When you look at the landscape, try to imagine what it looked like a million years ago or even a billion years ago. Then imagine what processes took place to create the landscape you see in front of you now. Being able to visualize the flow of gold through the landscape will help you make intelligent guesses what zones will produce gold and which will not.

Hillsides are the best areas for gold prospecting using a metal detector, because hillsides cannot be cleaned out by panning and dredging the way streams can. Also, gold on hillsides, not far from its source vein, tends to be larger, and hence more readily detected, than alluvial (placer) gold which tends to get pounded to pieces and worn away as it rolls along the streambed with gravel during floods.

## ***Geological areas settings in which to prospect with a metal detector***

1. Higher up in the terrain, there's gold in exposed quartz veins ("reefs").
2. Also higher up in the terrain, there's gold in the ground directly above quartz veins where the vein weathered in place.
3. Gold gradually moves down slope from its quartz vein source, carried by surface erosion and soil creep. So there's gold in that dirt.
4. Gold moving down slope eventually reaches a stream channel. There it is carried by water especially during floods, along with gravel and sand sediments.
5. Rising floods deposit sediment, including gold, above and alongside the stream channel. These sediments remain as terrace deposits when the floodwaters recede.

Alluvial (water flow) processes tend to concentrate what gold is present at specific spots, so if you hit a "hot spot" you may do very well. If you're searching for gold in stream placer, learn to "read the stream" to figure out where heavy sediments such as gold will tend to accumulate.

Placer gold is almost always associated with magnetite black sand. VLF metal detectors tolerate black sand in moderate concentration, but in heavy black sand they lose sensitivity, become noisy, and "overload". Under conditions of very heavy black sand the user must lift the searchcoil up away from the black sand in order to continue searching.

"Desert placer" comprises coarse sediments, often very deep, eroded from an original but now eroded "parent" mountain and deposited by flash floods and debris flows. In most cases drainage patterns are constantly changing as flow channels become clogged with debris and floodwaters find another course. On a given spot it's often hard to say where on the mountain the material came from. "Reading" the chaotic distribution of material in desert placer is an art difficult to learn, but those few who learn it are privileged to dig where nobody else has dug.

## ***Detecting Activities (continued)***

---

### ***Gold Prospecting (continued)***

In some cases the parent mountain no longer exists. When a desert placer land surface is no longer situated where deposition processes are active, weathering disintegrates the surface material and it is washed away by surface erosion. The gold, being heavy, is not so readily removed by erosion. Over many thousands of years the gold becomes concentrated in the surface material, resulting in an alluvial deposit.

Weathered-in-place residual gold (typically in soil above a gold-bearing quartz vein) is a good situation for metal detecting, fairly similar to a hill slope setting. The difference is that if you see quartz stones and are thinking there might be a gold-bearing quartz vein beneath, prospectors before you probably saw and thought the same thing. So, there will probably be prospect holes, and possibly even nearby hard rock mines. The early miners were looking for a mineable hard rock vein, but without a metal detector the overlying soil was useless to them. So always check the zone around prospect holes, as well as the prospect hole itself if it's safe to do so.

Mine tailings (mullock heaps) from hard rock mines are another favorite place to search. Previous miners in an area typically threw the rocks out if they didn't see gold with their eyes, and they often got so busy throwing out rocks that they missed seeing visible gold. A metal detector can find the mistakes of ancient or recent miners.

In many placer deposits, metal detectors go together well with the non-electronic traditional artisanal mining methods of panning, sluicing, and dredging. The larger rocks in the gravels cannot be processed by these methods, so they have to be thrown out. Someone already dug these rocks from a suspected or known pay streak: now they're on the surface loose, and probably even clean. Unless you happen to know that the larger rocks in this placer deposit virtually never contain gold, the rock piles can be a good place to use a metal detector.

In humid regions the soil is usually 20 inches (1/2 meter) or more thick, protected from surface erosion by vegetation cover. Gold is heavier than soil and tends to settle to bedrock. Therefore the gold in these regions are too deep to be detected with a metal detector. With the geology hidden underground, it's hard even to know where one ought to be searching. Therefore in humid regions the use of metal detectors is usually restricted to searching material which is not covered by soil—river gravels, rock outcrops, and rocky material excavated in mining operations. The use of metal detectors has historically been most profitable in arid regions. Desert soils are usually thin and rocky, with gold often lying exposed on the ground due to removal of lighter material from the land surface by erosion. And unlike in most humid regions, you can see the geology to guide you to where you should be searching.

Gold is valuable because it is a scarce commodity. Even in a good gold producing area, you may spend an entire day without finding any gold. Meanwhile you may dig bits and pieces of other metal. "Hot rocks" -- rocks containing concentrations of iron oxides that sound like metal when you pass over them -- are also a nuisance in many gold areas.

If you have gone many hours without finding gold and are wondering if there is something wrong with your metal detector or how you are using it, the most important clue is this: if you are digging *tiny* pieces of trash metal, then if you had swept over gold nuggets, you would have dug them too!

## Detecting Activities (continued)

---

### Gold Prospecting (continued)

When something that sounds like gold has been detected, most of the time it's iron metal or a hot rock. Always carry a strong magnet, and stick the magnet into the dirt where the detected object is. Iron will be drawn to the magnet, and hot rocks usually will be as well. Even if you pull iron metal or hot rocks out, always check again with the metal detector to see if there is gold (which of course won't be drawn to the magnet). A good magnet is what a gold prospector uses instead of "Discrimination Mode".

Most gold nuggets are very small, and are most often found in soil which is high in iron oxide minerals. Therefore serious gold prospecting requires a detector with high sensitivity and with true ground balanced motion all metals operation. Run the machine with the sensitivity high enough to hear some noise from ground minerals, and *learn the language* of the sounds you hear. Most prospectors prefer to use headphones unless consideration for safety (for instance rattlesnakes) rules them out. Move the searchcoil slowly and deliberately, carefully controlling its height above the ground to minimize noise from iron minerals in the soil. If you hear ground noise, your ground balance setting could be a bit off, so perform the ground balancing procedure again. In some areas the ground changes over very short distances and you'll have to pay close attention to ground balance.

Some "gold machines" display the amount of iron mineralization in the ground. In alluvial (placer) deposits, gold tends to be associated with iron minerals, particularly magnetite *black sand*. If you know this to be the case in the area you're working, you can maximize your gold recovery by concentrating your effort on areas where the display indicates higher amounts of iron mineralization.

Remember to always carry a magnet when gold prospecting. And follow these guidelines:

### Using a magnet as a "hot rock discriminator"- a summary

- Iron metal is **always** strongly attracted to a magnet. Steel (iron alloys) are almost always strongly attracted to a magnet.
- Magnetite hot rocks and black sand are **always** strongly attracted to a magnet.
- Other negative hot rocks are **almost always** attracted to a magnet, but not as strongly as magnetite.
- Positive hot rocks are **usually** attracted to a magnet, but the attraction is often weak.
- Meteorites detected by a metal detector are **usually** attracted to a magnet. The attraction may be strong or weak.
- Gold and other nonferrous metals are **never** attracted to a magnet.

### Cache Hunting

A *cache* (pronounced "cash") is an accumulation of money, jewelry, gold, or other valuables, which someone has hidden. When people bury a cache, they usually put it in a strongbox or in a jar. To search for a cache, you first need a reason to believe the cache may exist. This means doing research. Some caches have been the subject of many stories you can read about in print, but you need to be able to sort fact from fiction. If you can get copies of old newspaper

## ***Detecting Activities (continued)***

---

### **Cache Hunting** *(continued)*

stories about the circumstances surrounding the hiding of the cache, you may find discrepancies which help you to judge the reliability of the information available. Often the best information on an old cache is to be learned from old timers who live in the area where the cache is thought to be. In the case of newer caches, often the only information is what can be obtained from family and acquaintances of the person who is believed to have hidden the cache.

The ownership of a cache is not always clear. Sometimes it belongs to the person or heirs of the person who hid it, sometimes it belongs to the owner of the property on which it is located, and sometimes it belongs to the person who finds it — or some combination of the above. If the contents of the cache were stolen, this fact can also complicate the question of ownership. Find out what laws apply to the cache in question, and always make sure that the issue of ownership is resolved prior to recovering a cache.

Compared to a coin, a cache is usually large and deep. Searching in All Metal Mode is recommended. However, for a really deep cache, it may be advantageous to search in Pinpoint, frequently releasing the trigger momentarily to maximize sensitivity.

### ***Shallow Water Hunting***

All **First Texas Products** searchcoils are waterproof, allowing you to search in shallow water about two feet deep. If searching around water, be careful not to get the electronics housing wet. Avoid salt spray, as it will work its way into the control housing and damage the electronics — such damage is not covered by the warranty.

Both fresh and salt water beaches are popular places for metal detecting. Vacationers lose money and jewelry playing in the sand and in the water. It is usually easy to dig in a beach environment, and metal detecting is permitted on most beaches. Occasionally you may be able to help someone recover a piece of jewelry they have lost minutes before, this is a gratifying experience.

When searching on a beach, it is best to either search in All Metal Mode, or to search with the discrimination level set just high enough to eliminate iron, because the value of beach finds is largely in the jewelry rather than in the coins. You will dig a lot of aluminum trash, but the digging is easy, and you can tell people that you are helping to clean up the beach and make it safer for people's feet. We recommend the use of special *sand scoop* for recovering valuables from the sand quickly — most metal detector dealers sell these.

The electrical conductivity of the water itself can pose some challenges. You may get false signals when going into and coming out of the water, making it necessary to pay careful attention to keep the coil either in or out of the water, but not to touch the surface. This effect may be observed in either fresh or salt water.

Salt water is highly conductive, and produces a strong signal which is like that of metal. Therefore the  $T^2$  is not suitable for use in or over salt water. In order to use the  $T^2$  over wet sand, or salt water beaches, do the following:

1. Set the sensitivity in both modes to 30 or less.
2. Ground cancel the machine manually in All Metal Mode.
3. Search in the Discrimination Mode with a discrimination setting higher than 45, using the 1+ # OF TONES method.

## **HOW METAL DETECTORS WORK**

---

Most hobby metal detectors use *VLF Induction Balance* technology. Here's how they work.

The searchcoil (also called search head or loop) contains two electrical induction coils which are like antennas. One coil transmits a rapidly alternating magnetic field, *illuminating* the region surrounding the searchcoil. If metal is present, its electrical conductivity distorts the magnetic field. If iron metal is present, its magnetism also distorts the magnetic field, but in a different way, allowing the metal detector to distinguish between ferrous and nonferrous metals.

The other coil is a receiving antenna which detects changes in the magnetic field caused by the presence of metal. Electronic circuits amplify this weak signal, analyze it to determine the changes which occur as the searchcoil sweeps over the target, and then convey the information to the user in the form of a visual display or audio tones. Most modern metal detectors perform many of these tasks in software running on an internal microcomputer.

The iron minerals which are present in most soils also distort the magnetic field, obscuring the weak signals of small or deep objects. This can cause the object to go undetected, or to be misidentified when it is detected. Much of the technology that goes into modern metal detectors is devoted to the task of eliminating the unwanted signals from iron minerals in the soil, while not losing the signals from metal objects.

*Copyright© First Texas Product, L.L.C. 2019*

## ***TREASURE HUNTER'S CODE OF ETHICS:***

---

- Always check Federal, State, County and local laws before searching.
- Respect private property and do not enter private property without the owner's permission.
- Take care to refill all holes and leave no damage.
- Remove and dispose of any and all trash and litter found.
- Appreciate and protect our inheritance of natural resources, wildlife and private property.
- Act as an ambassador for the hobby, use thoughtfulness, consideration and courtesy at all times.
- Never destroy historical or archaeological treasures.
- All treasure hunters may be judged by the example you set; always conduct yourself with courtesy and consideration of others

## ***5-YEAR LIMITED WARRANTY***

---

The **T<sup>2</sup>** metal detector is warranted against defects in materials and workmanship under normal use for five years from the date of purchase to the original owner.

Damage due to neglect, accidental damage, or misuse of this product is not covered under this warranty. Decisions regarding abuse or misuse of the detector are made solely at the discretion of the manufacturer.

**Proof of Purchase is required to make a claim under this warranty.**

Liability under this Warranty is limited to replacing or repairing, at our option, the metal detector returned, shipping cost prepaid to First Texas Products. Shipping cost to First Texas Products is the responsibility of the consumer.

To return your detector for service, please first contact First Texas for a Return Authorization (RA) Number. Reference the RA number on your package and return the detector within 15 days of calling to:



**First Texas Products L.L.C.**

1120 Alza Drive

El Paso, TX 79907

Phone: 1-800-413-4131

### **NOTE TO CUSTOMERS OUTSIDE THE U.S.A.**

This warranty may vary in other countries, check with your distributor for details.  
Warranty does not cover shipping costs.

According to FCC part 15.21 Changes or Modifications made to this device not expressly approved by the party responsible for compliance could void the users authority to operate this equipment.

This device complies with FCC Part 15 Subpart B Section 15.109 Class B.

MADE IN USA

# ACCESSORIES

## Teknetics® Padded Carrying Bag

Made of rugged double-stitched nylon construction. Includes handy outside zip-pocket for extra batteries or small accessories. – *CBAG-T*



## Stereo Headphones

Use with Teknetics® metal detectors with true stereo. Utilizes 1/4-inch stereo & 1/8-inch plug. Compatible with all Teknetics® models with 1/4-inch & 1/8-inch jacks. – *HEADT*

## Pinpointer

Pinpoints the exact location of buried metal objects. Audio signal indicator and vibrator. No assembly required, runs on (1) 9-Volt Battery. – *PINPOINTER*



## Teknetics® Gold Pick

Tempered steel head is 10" long and the edge is 3 1/4" wide. The overall length is 19" with a durable fiberglass handle and a rubberized hand grip. Includes a powerful super magnet attached to the head to quickly discriminate iron targets and magnetic hot rocks. – *GOLDPICK*



## Replacement/Accessory Searchcoils

- 15"DD Elliptical, Open (Accessory) Coil – *15COIL-T2*
- 11"DD Elliptical, Open (Replacement) Coil – *11COIL-T2*
- 5"DD Round, Closed (Accessory) Coil – *5COIL-T2*

## Coil Covers

- 15"DD Elliptical Accessory Coil Cover – *15COVER-11PP*
- 11"DD Elliptical Standard Coil Cover – *COVER-11DD*
- 5"DD Round Accessory Coil Cover – *5COVER-BLK*

## Lesche Knife

Made from high quality heat-treated tempered steel. The ultimate digging tool. Comes with a durable sheath 12" in length with a 7" serrated blade. – *LESCH KNIFE*



## Neoprene Elbow Rain Cover (not shown)

Specially made to protect your Teknetics® T2 from weather. – *ELBOW-COVER*

## Neoprene Face Rain Cover

Specially made to protect your Teknetics® T2 from weather. – *FACE-COVER*

## Teknetics® T-Shirt\* 100% cotton with

Teknetics® Logo. Sizes – S, M, LG, XL & XXL – *TKTSHIRT*

## Teknetics® Baseball Cap

One size fits all. – *TKCAP*



## Gold Prospecting Kits

Items Included:	Gold Kit PART NUMBER: GOLDKIT1	Deluxe Kit PART NUMBER: GOLDKIT2	Hardrock Kit PART NUMBER: GOLDKIT3
10 1/2" Gold Pan	x	x	x
14" Gold Pan	x	x	x
Classifier		x	x
2 – Shatterproof Vials	x	x	x
Snuffer Bottle	x	x	x
Black Sand Magnet		x	x
Treasure Scoop		x	x
Tweezers			x
Magnifier			x
Crevice Tool			x
Rock Pick			x
Instruction Booklet	x	x	x
Backpack		x	x



FOR COMPLETE DETAILS VISIT [WWW.TEKNETICSDIRECT.COM](http://WWW.TEKNETICSDIRECT.COM) • 1-800-413-4131