

TEKNETICS®

eurotek®
PRO
METAL DETECTOR

OWNER'S MANUAL



Model #:
ETEKPRO11DD-SKD
comes standard with
the 11" Biaxial DD
searchcoil



Use a 9-volt **ALKALINE** battery only.
Do not use "Heavy Duty" batteries.
Do not use ordinary Zinc Carbon batteries.

Congratulations!

Congratulations on your purchase of the new Eurotek® Pro Metal Detector. Eurotek is the result of years of research and development to bring you a detector designed specifically for European Treasure Hunting conditions. Treasure Hunting enthusiasts from around the world were involved in the development of this revolutionary new detector. The Eurotek has Target-ID resolution never before seen in a detector in this price range. FeTone™: Adjustable Iron Audio Volume and V-Break™: Variable Tone Breakpoint features are also an industry first. This manual has been written to help you get optimal use of your detector, so we hope you will read it thoroughly before your first outing.

Happy Hunting from First Texas Products!

TABLE OF CONTENTS

Terminology	3
Assembly	4-5
Batteries	6
Quick-Start Demo	7
Basics of Metal Detecting	
Ground Minerals	8
Trash	8
Identifying Buried Objects	8
Size and Depth of Objects	8
Electromagnetic Interference	9
Headphones	9
Operation and Controls	
Power On and Work the Controls	10
Menu Selections	
Overview	11
Sensitivity	11
Discrimination	12
Volume	13
Discrimination System	
Target Detection	14
Target-ID	14
3-Tone System	15
DISC control and V-Break™, Variable Tone Breakpoint	17
Depth Indicator	18
Coin Reference Table	18
Mode Selections	
Iron Identification and FeTone™, Adjustable Iron Audio	19
Pinpoint Mode	19
Depth Indicator	20
Retuning	20
How To	20
Narrow It Down	20
Other Features	21
Overload	
Unit of Measure	
Memory	
Reset	
Troubleshooting	22
Accessories	23
Code of Ethics & Warranty	24

TERMINOLOGY

The following terms are used throughout the manual, and are standard terminology among detectorists.

ELIMINATION

Reference to a metal being "eliminated" means that the detector will not emit a tone, nor display a Target-ID, when a metal object passes through the searchcoil's detection field.

DISCRIMINATION

When the detector emits different tones for different types of metals, and when the detector "eliminates" certain metals, we refer to this as the detector "discriminating" among different types of metals.

Discrimination is an important feature of professional metal detectors. Discrimination allows the user to ignore trash and otherwise undesirable objects.

RELIC

A relic is an object of interest by reason of its age or its association with the past. Many relics are made of iron, but can also be made of bronze or precious metals.

IRON

Iron is a common, low-grade metal that is an undesirable target in certain metal detecting applications. Examples of undesirable iron objects are old cans, pipes, bolts and nails.

Sometimes, the desired target is made of iron. Property markers, for instance, contain iron. Valuable relics can also be composed of iron; cannon balls, old armaments and parts of old structures and vehicles can also be composed of iron.

FERROUS

Metals which are made of, or contain, iron.

PINPOINTING

Pinpointing is the process of finding the exact location of a buried object. Long-buried metals can appear exactly like the surrounding soil, and can therefore be very hard to isolate from the soil.

V.C.O.

Meaning "voltage controlled oscillator," the V.C.O. audio method causes both the *audio pitch* and the *volume* to rise as signal strength increases. V.C.O. improves the user's ability to interpret a target's size and depth. Very weak signals (for small or very deeply buried objects) have the faintest volume and the lowest pitch. Larger objects, and those closer to the searchcoil, will induce a higher volume and higher pitch sound.

GROUND BALANCE

Ground Balancing is the ability of the detector to ignore, or "see through," the earth's naturally occurring minerals, and only sound a tone when a metal object is detected. This detector incorporates proprietary circuitry to eliminate false signals from severe ground conditions.

PRE-ASSEMBLY

Unpack your detector to find the following contents:



1. Control Housing

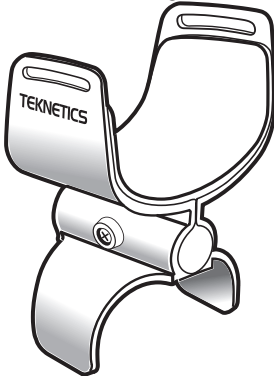

2. Armrest Assembly with Screw and Lock-Nut

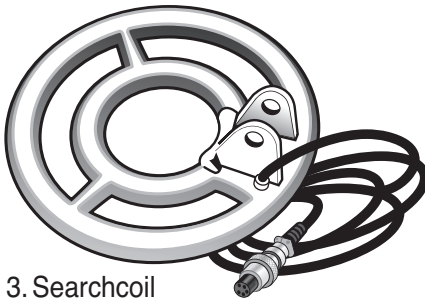

3. Searchcoil

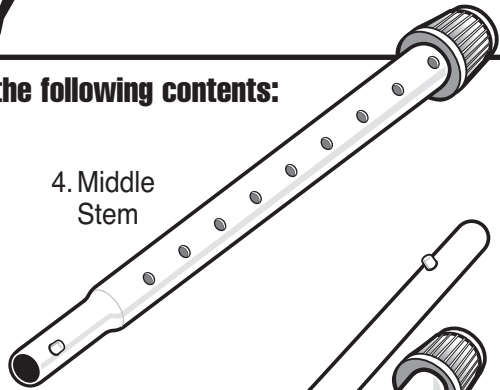

4. Middle Stem

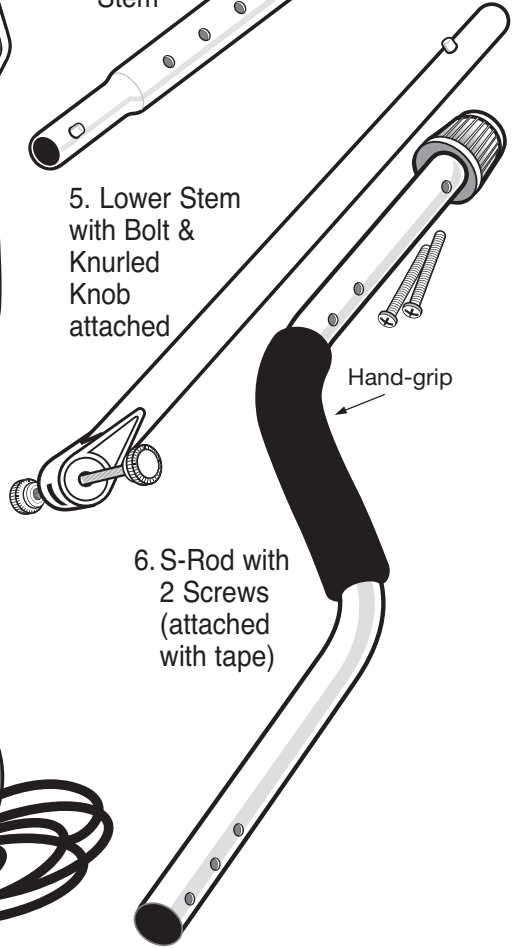

5. Lower Stem with Bolt & Knurled Knob attached

6. S-Rod with 2 Screws (attached with tape)

Tool Required: #1 Phillips Screwdriver

- Remove the Screw from the Armrest.
 - Slide the Armrest over the end of the S-Rod.
 - Attach with Screw and Lock-Nut.
- Attach Control Housing with 2 screws; install back screw first.

NOTE: The Hand-grip fits under the Control Housing.
Peel back Hand-grip to expose the front hole.

ASSEMBLY

Caution: Forcing in MIDDLE STEM with CAM LOCK raised may form a burr on camlock. If this happens, remove burr with knife to allow insertion.

- 1 Position S-Rod upright.
- 2 Rotate the LOCKING COLLAR fully in the counterclockwise direction.
- 3 Insert your finger inside the tube and make sure the INTERNAL CAM LOCK is flush with the inside of the tube.

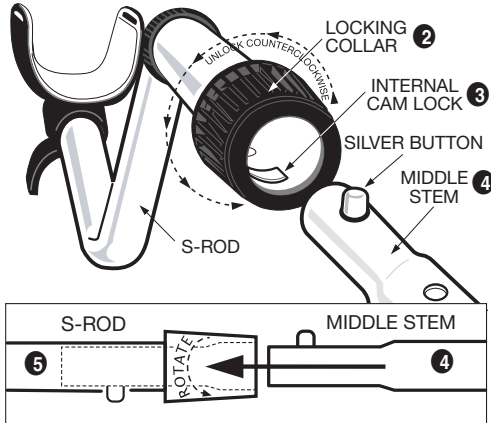

- 4 Insert the MIDDLE STEM into the S-ROD, with the SILVER BUTTON pointed upward
- 5 Rotate the MIDDLE STEM until the SILVER BUTTON locates in the hole.
- 6 Twist the LOCKING COLLAR fully in the clockwise direction until it locks.
- 7 Repeat this process on the LOWER STEM.
- 8 Using the BOLT and KNURLED KNOB, attach the SEARCHCOIL to the LOWER STEM.
- 9 Adjust the LOWER STEM to a length that lets you maintain a comfortable upright posture, with your arm relaxed at your side, and the SEARCHCOIL parallel to the ground in front of you.
- 10 Wind the CABLE securely around the STEMS, leaving slack at the bottom.
- 11 Connect CABLE PLUG to housing. Do not twist the Cable or Plug. Turn Locking Ring only. Use minimal finger pressure to start the threads. Do not cross-thread. When the Locking Ring is fully engaged over the threaded connector, give it a firm turn to make sure that it is very tight. When the Locking Ring is fully engaged over the threaded connector, it may not cover all of the threads.
- 12 Tighten both LOCKING COLLARS.

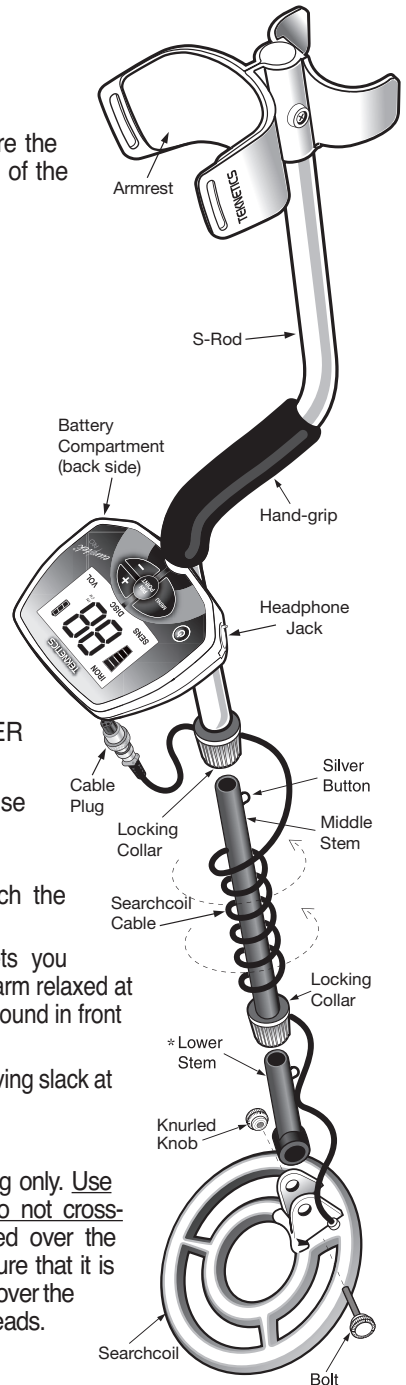

* Note: Very tall users can purchase the optional Extended Lower Stem (TUBE5X), for extended reach.

BATTERIES

The detector requires a single 9-volt **ALKALINE** battery (battery not included).
Do not use ordinary Zinc Carbon batteries.
Do not use “Heavy Duty” batteries.

Rechargeable batteries can also be used.
If you wish to use rechargeable batteries, we recommend using a Nickel Metal Hydride rechargeable battery.

The battery compartment is located on the back side of the housing.
Slide the battery door to the side and remove it to expose the battery compartment.
For easy battery removal, push down firmly on the bottom of the battery (*see illustration*).

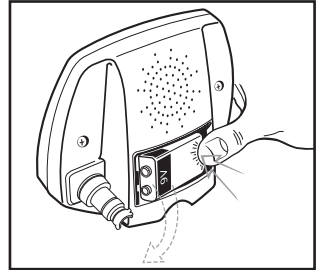

BATTERY LIFE

Expect 20 to 25 hours of life from a 9-volt alkaline battery.
Rechargeable batteries provide about 8 hours of usage per charge.

BATTERY INDICATOR

The battery icon at the top-right of the display has three vertical segments and an outline segment.

The amount of battery voltage for an ALKALINE battery is indicated as follows:

- | | |
|-----------------------------------|-------------------|
| 3 vertical segments illuminated: | 8.1 volts or more |
| 2 vertical segments illuminated: | 7.1 to 8.0 volts |
| 1 vertical segment illuminated: | 6.5 to 7.0 volts |
| No vertical segments illuminated: | 6.2 to 6.4 volts |
| Outline Flashing: | 6.1 volts or less |



SPEAKER VOLUME AND BATTERY CHARGE

You may notice the speaker volume drop while one battery segment is illuminated.
With the outline flashing, low speaker volume will be very apparent.

BATTERY DISPOSAL & RECYCLING

Alkaline batteries may be disposed of in a normal waste receptacle or recycled.
Non-Alkaline batteries should be recycled. In the state of California all battery types must be recycled. Please refer to local municipalities for detailed disposal and recycling requirements.

Armrest Strap (optional accessory)

The strap is available for purchase as a separate accessory. Some users prefer to use the strap when swinging the detector vigorously in order to hold the detector secure against the arm.

The detector can also be used without the strap, with no compromise to detector balance and stability under most conditions.

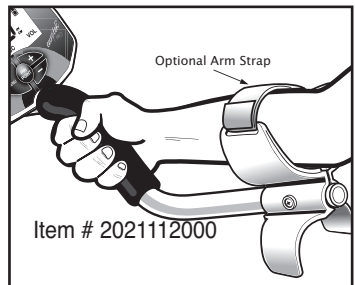

QUICK-START DEMONSTRATION

I. Supplies Needed

- a Nail • a Gold Ring (try several different size gold rings) • a Large Silver Coin

II. Position the Detector

- Place the detector on a table, with the searchcoil hanging over the edge. Or better, have a friend hold the detector, with the searchcoil off the ground.
- Keep the searchcoil away from walls, floors and metal objects.
- Remove watches, rings and jewelry.
- Turn off lights or appliances, whose electromagnetic emissions may cause interference.
- Pivot the searchcoil back.

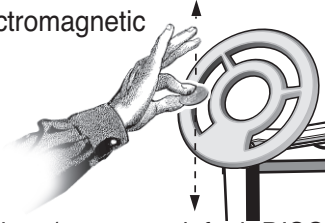

III. Power Up

Press .



IV. Wave each object over the searchcoil

- Notice the tones and Target-IDs for each object (assumes default DISC setting):

OBJECT	TARGET-ID	STONE
Nail	lower (e.g. 10-35)	LOW
Gold Ring	medium (e.g.- Mid 50's)	V.C.O.
Larger Gold Ring	medium (but higher than ID for smaller gold ring)	V.C.O.
Silver Coin	higher (e.g.- 80-99)	High

- Motion is required.
 - Objects must be in motion over the searchcoil to be detected.
 - Sweep objects flat over the searchcoil, parallel to the plane of the searchcoil.

V. Press twice to activate the DISC selection

- While sweeping the Nail back-and-forth, press  to increase the DISC setting.
 - Continue to press  and increase the DISC setting.
 - Notice that the Nail will be eliminated from detection at a certain DISC setting. The nail is eliminated when the DISC setting is 40 numbers greater than the target's ID.
- Caution:** Passing the nail at differing angles will yield different ID numbers.
- When the Nail is eliminated from detection, the IRON segment will still flash but no tone will sound and no Target-ID will be indicated.

VI. Repeat Step V while waiving the Gold Ring, and then also while waiving the Silver Coin

- Notice that the Gold Ring will be eliminated from detection.
- If the ID of the Silver Coin is greater than 80, then it will not be eliminated from detection. But if the coin's ID is less than 80, the tone will change from V.C.O. to High Tone as DISC is adjusted.

VII. Press and hold PINPOINT

- Hold a metal object motionless over the searchcoil.
- Notice that motion is not required for detection.
- Move the object closer, then farther away from the searchcoil.
 - Notice the changing sound.
 - Notice the changing depth values.

THE BASICS OF METAL DETECTING

This metal detector is intended for locating buried metal objects. When searching for metals, underground or on the surface, you have the following challenges and objectives:

1. Ignoring signals caused by ground minerals.
2. Ignoring signals caused by metal objects that you do not want to find, like nails.
3. Identifying a buried metal object before you dig it up.
4. Estimating the size and depth of objects, to facilitate digging them up.
5. Eliminating the effects of electromagnetic interference from other electronic devices.

Your metal detector is designed with these things in mind.

1. Ground Minerals

All soils contain minerals. Signals from ground minerals can interfere with the signals from metal objects you want to find. All soils differ, and can differ greatly, in the type and amount of ground minerals present. The Eurotek Pro has a preset ground elimination setting. No user adjustments are required.

2. Trash

If searching for coins, you want to ignore items like aluminum foil and nails. You can see the Target-ID value of the buried objects, listen to the sounds, and then decide what you want to dig up. Or you can eliminate unwanted metals from detection by using the DISCRIMINATION feature.

3. Identifying Buried Objects

Metal objects are identified by a 2-digit number on the display screen. This scale has 99 points of resolution, and is an indicator of the relative electrical conductivity of different objects. Higher numbers indicate more conductive targets. Iron objects, which are usually of lesser value, display lower numbers. Silver coins, for instance, usually display the highest numbers.

4. Size and Depth of Buried Objects

The 5-digit bar graph indicates the relative depth of a buried metal object. This bar graph can indicate the relative size of different objects or their distance from the searchcoil. For a given object, the more distance between it and the searchcoil, the more bars illuminated. A more accurate, and higher resolution, depth reading is available when using the Pinpoint Mode. The Pinpoint Mode does not require the searchcoil to be in motion to detect metals. The ability to hold the searchcoil motionless over the target also aids in tracing an outline of the buried object, or in pinpointing the exact location of the object using techniques described in the pinpointing section of this manual.

THE BASICS OF METAL DETECTING

5. EMI (Electromagnetic Interference)

The searchcoil produces a magnetic field and then detects changes in that magnetic field caused by the presence of metal objects. This magnetic field that the detector creates is also susceptible to the electromagnetic energy produced by other electronic devices. Cell phones, cell phone towers, power lines, microwave ovens, lighting fixtures, TVs, computers, motors, etc... all produce EMI which can interfere with the detector and cause it to beep when no metal is present, and sometimes to beep erratically.

The SENSITIVITY control lets you reduce the strength of this magnetic field, and therefore lessen its susceptibility to EMI. You may want to operate at maximum strength, but the presence of EMI may make this impossible, so if you experience erratic behavior or “false” signals, **reduce the sensitivity.**

HEADPHONE JACK

Push the tab up and lock into place to expose the headphone jack. This detector has a 1/4” headphone jack. It works with any stereo headphone that has a 1/4” plug. When the headphone jack is connected, speaker volume is disabled.

USING HEADPHONES

Using a detector with headphones facilitates detection of the weakest signals and also extends the battery life.

It also allows you to hear subtle changes in the sound more clearly, particularly if searching in a noisy location. For safety reasons, do not use headphones near traffic or where other dangers are present. This device is to be used with interconnecting cables/headphone cables shorter than three meters.

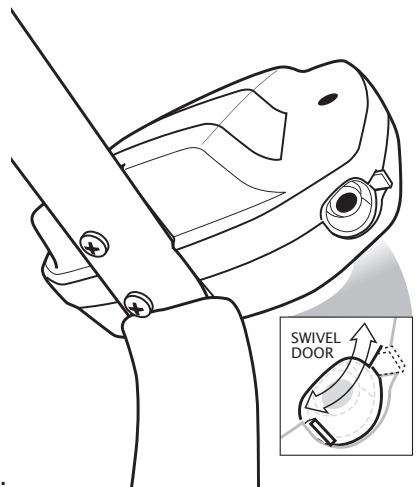

OPERATION and CONTROLS

POWERING UP

NOTE: Immediately after powering on, your detector's unique 10-digit serial number is displayed once on the LCD. Two digits are displayed at a time; five 2-digit numbers are displayed in sequence. This 10-digit serial number is the same serial number imprinted on the label inside the battery compartment.

Press  The detector powers on.

A “**d**” appears momentarily, indicating that the detector is in the Discrimination Mode of operation.

All targets are detected. Motion is required.

Default sensitivity is 7, on scale of 1 to 10.

Default volume is 7, 70% of maximum.

HOW TO WORK THE CONTROLS

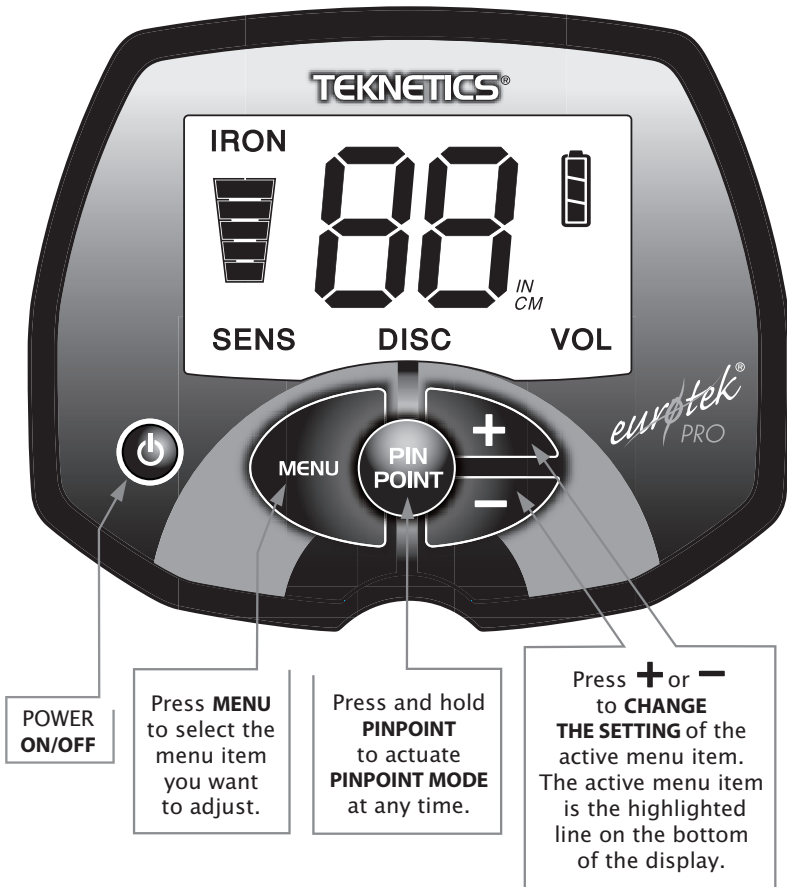

MENU SELECTIONS

Operational Overview



Press  to activate the menu system: SENS, DISC or VOL.

At first activation of the menu system, the SENS menu selection appears.

Successive presses of  will toggle through the menu selections.

With a menu selection visible, press  or  to change settings for that menu selection.

When you reach the desired setting, as indicated by the 2-digit value on the display, no further action is necessary.



- 4 seconds after the last  or  key-press, the menu icon will time-out and the last displayed setting will be programmed in.
- Or press  again before the display times out, and advance to the next menu selection; the last displayed setting will be programmed in.

During operation, recall the last menu selection by pressing MENU at any time; the last menu selection adjusted will again be displayed.

While the MENU display is active, the LCD display will not respond to targets, but the audio target system will continue to respond to any target or overload signal.

1. SENS (Sensitivity)

Press  to illuminate the SENS menu icon.

Use  and  to increase or decrease sensitivity while SENS is highlighted.

Maximum sensitivity setting is 10.

Minimum sensitivity setting is 1.

If the detector beeps erratically or beeps when there are no metal objects being detected, **reduce the sensitivity.**

The searchcoil produces a magnetic field and then detects changes in that magnetic field caused by the presence of metal objects. This magnetic field that the detector creates is also susceptible to the electromagnetic energy produced by other electronic devices. Cell phones, cell phone towers, power lines, microwave ovens, lighting fixtures, TVs, computers, motors, etc.... all produce EMI which can interfere with the detector and cause it to beep when no metal is present, and sometimes to beep erratically.

MENU SELECTIONS

HOW DEEP WILL IT GO?



The Eurotek Pro Metal Detector will detect a coin-sized object to a distance of about 24 cm (9.5") from the searchcoil at maximum sensitivity. Large metal objects can be detected to a depth of more than a meter. Detectability is directly related to the size of the metal object -- the larger the object, the deeper it can be detected.



Accuracy of target identification is also related to distance from the searchcoil. Beyond a distance of 20 cm (8"), the accuracy of target identification begins to diminish.

2. DISC (Discrimination)

The discrimination system in the Eurotek Pro is unlike systems in other metal detectors.

Press  to illuminate the DISC menu icon.

With each press of  or , the DISC setting changes by one.

Press-and-Hold  or  to rapidly advance or reduce the DISC setting.

Target IDs from 1 to 69 can be eliminated from detection. Target IDs from 70 to 79 cannot be eliminated, but the user can change tones in this range.

See the DISCRIMINATION section of the manual for a complete description of the DISC function.

MENU SELECTIONS

3. VOL (Volume)

Press  to illuminate the VOL menu icon.
The default volume setting is 7.

Press  to increase speaker volume. Maximum volume is at setting 20.

Press  to lower speaker volume. The minimum volume setting is 0, no sound.

With volume set to 0, the Target-ID, Depth Bar Graph and Iron-Indicator will function as normal, but the detector will not emit a sound when targets are detected.

The overload volume signal will always sound off in the event of signal overload, even with the volume set to 0.

Because the Eurotek Pro is so sensitive to even the smallest iron targets, the detector incorporates **FeTone™**, Adjustable Iron Audio, a feature to reduce the volume of iron targets to minimize user fatigue.

Volume settings 10 - 20 are available to control the volume level of iron targets.

As you increase volume from 10 to 20, iron-volume changes from silent to maximum. Note that, depending on the DISC setting, iron targets may induce V.C.O. tones; in this case, the V.C.O. tones in the iron range (ID 1 - 40) will also have the same reduced volume.

At each of the 10 - 20 volume settings, nonferrous target response is maximum volume.

Volume control applies only to motion target detection.

Volume changes do not affect the Pinpoint Mode volume, or the keypad volume.

Volume Settings are as follows:

Setting	Volume	
	Nonferrous	Ferrous
1	1	1
2	2	2
3	3	3
4	4	4
5	5	5
6	6	6
7	7	7
8	8	8
9	9	9
10	10	0

Setting	Volume	
	Nonferrous	Ferrous
11	10	1
12	10	2
13	10	3
14	10	4
15	10	5
16	10	6
17	10	7
18	10	8
19	10	9
20	10	10

DISCRIMINATION SYSTEM

Target Detection

Sweep the detector back-and-forth over the ground.

Keep the searchcoil parallel to the ground as you sweep; do not lift the searchcoil at the ends of your sweeps.

Searchcoil motion is required for target detection (except in Pinpoint Mode).

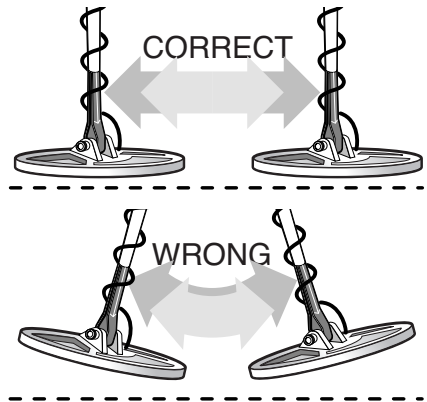

Target-ID

When objects are detected, the detector will emit a sound and a 2-digit Target-ID will appear on the screen. Possible Target-IDs range from 1 to 99. This number represents the electrical conductivity of the target detected; higher numbers indicate more highly conductive targets.

The 2-digit number indicates the Target-ID of the last object detected. The Eurotek Pro has a very fast target response and is able to detect different objects in very close proximity. Therefore, the Target-ID displayed may change rapidly as you sweep the searchcoil.

Three seconds after the last Target-ID is displayed, the Target-ID will time-out and the number will disappear.



Bulgarian 10 stotinkas, 1999



Bulgarian 50 stotinkas, 1999 - 2007



Peter I, 1705, Silver, 0.25 gr.



Mikhail Fedorovich, 1613-1645



50 kopeek Nikolay II, 1896, Silver



5 kopeek, Ekaterina II, 1781



2 kopeek, Alexander I, 1816



10 ct Napoleon III (bronze, France)

DISCRIMINATION SYSTEM

Target-ID (continued)

As a general reference, targets fall into the following ranges:

- 1 - 39: iron
- 42 - 48: foil and small gold nuggets
- 54 - 57: gold nuggets, gold rings or targets containing mostly gold
- 87 - 89: clad coins or coins of recent vintage
- 82 - 83: copper coins
- 93 - 99: larger silver coins

Note: There are a wide variety of metals and no target can be identified for certain until unearthed. This table is for general reference only.

See the table on P. 18 for a more complete listing of Target-ID values for common metal items.

3-Tone System

Depending on the type of metal detected, and the DISC setting of the detector, a buried metal object will induce one of the following sounds:

No sound: metals eliminated from detection (or discriminated-out), with the DISC function.

Low Tone: targets with an ID less than 40.

V.C.O. (variable pitch and volume):

- Targets with an ID between 40 and 69.
- Targets between 70 and 79 when DISC setting is greater than or equal to the Target-ID.

High Tone: - All targets with an ID of 80 or greater.

- Targets with an ID between 70 and 79 if the DISC setting is less than the Target-ID.

Depending on where the user programs the DISC setting, a given target may induce different tones.

DISCRIMINATION SYSTEM

3-Tone System *(continued)*

The discrimination system in the Eurotek Pro is unlike systems in other metal detectors.

- The default DISC setting is 0. When the detector is first powered on, all targets are detected.
If the user saves different DISC settings (see Memory function, p. 21), then this may change at power-up.
- As the DISC setting is adjusted, targets with IDs less than or equal to DISC are eliminated from detection.
This target elimination scheme, common to many detectors, is applicable to Target-IDs up to 69.
- For DISC settings greater than 69, targets in this range are not eliminated. Rather, the tone changes from High Tone to V.C.O.
In this range, the DISC setting becomes the V-Break™, Variable Tone Breakpoint.
- The highest DISC setting possible is 79.
If the DISC setting is 79, then:
 - All Target-IDs less than 70 are eliminated from detection
 - All Target-IDs between 70 and 79 induce V.C.O. Tones.
 - All Target-IDs greater than 79 induce a High Tone.

The Target-ID system and the Audio-ID systems on the Eurotek® Pro operate independently. Therefore, there may be times when the tones and IDs seem inconsistent. For example, a very deeply buried target may induce a low tone, but the signal may be too weak for the visual ID system to determine, with confidence, a reliable Target-ID number. In this case, the detector may not register a visual Target-ID, even though the detector emits a tone.



***1/4 of Stater,
gold, France***



***2 Franc Morlon,
aluminum***



***Medieval double
sol***



***50cent Chambre
du Commerce***



***Double
Tournois,
copper***



***Roman
Nummus,
bronze***



***Celtic Potin,
mixed metal***



***Merovingian
Triens, gold***

DISCRIMINATION SYSTEM

Below is an illustration of how the DISC control and V-Break™, Variable Tone Breakpoint, operate:

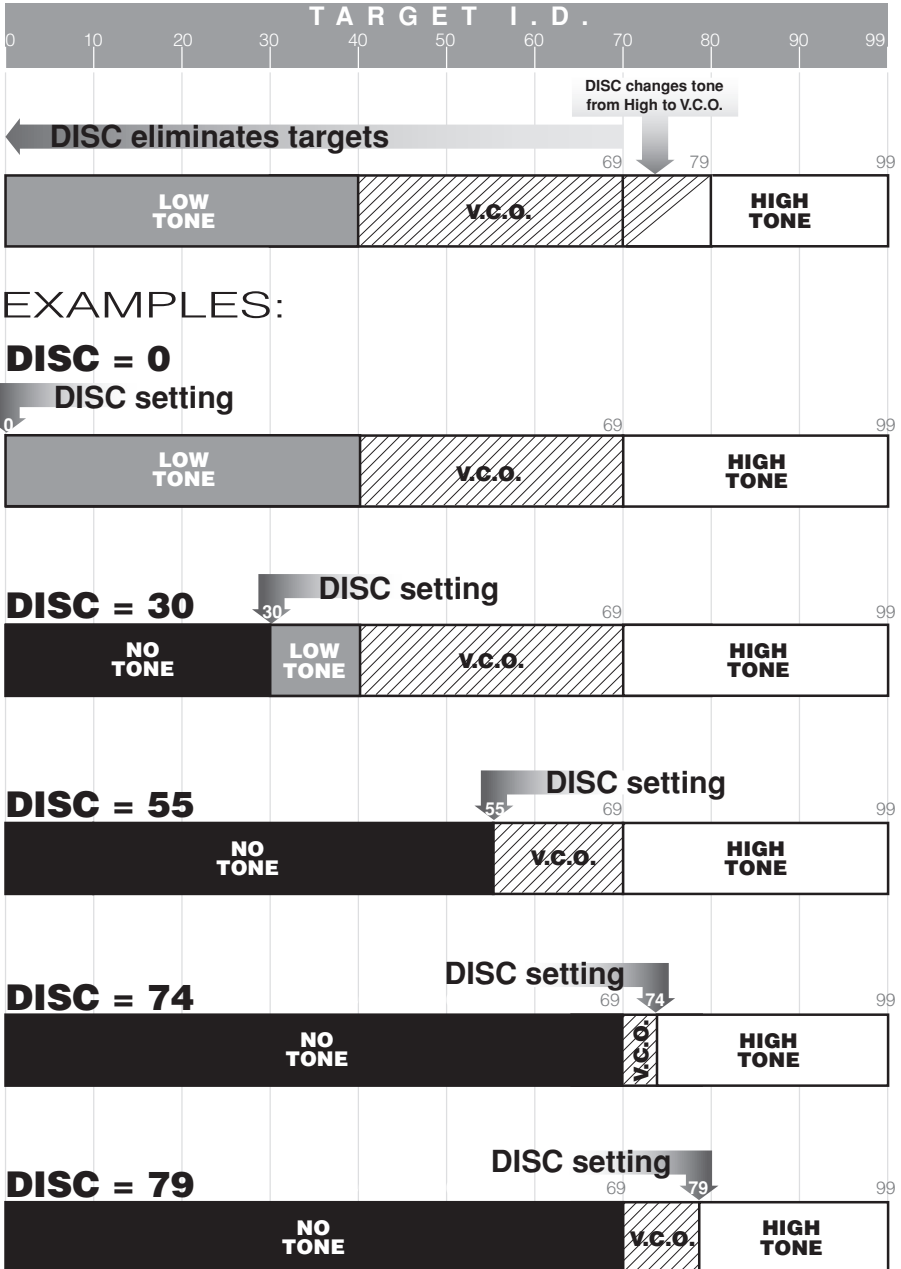

DEPTH INDICATOR

In Discrimination Mode, each time an object is detected, a Bar Graph illuminates in addition to the Target-ID.

The Bar Graph is a graphic representation of the distance from the searchcoil, and is calibrated to a coin-sized object.

- More bars indicate a deeper object.
- Fewer bars indicate a shallower object.

The scale for coin-sized objects, with sensitivity at maximum, is:

Display:



Depth:

>20cm
(8")*

15cm-20cm
(6"-8")

10cm-15cm
(4"-6")

6cm-10cm
(2.5"-4")

<6cm
(2.5")**

* 5 Bars: If the object is a coin, it is deeply buried.

...or this could be the faint signal from a large, but very deeply buried, object.

** 1 Bar: If the object is a coin, it is shallow.

...or this could be a large object more deeply buried.

Target-ID Coin Reference. Below are known Target-IDs for some reference coins:

Mеровingian Triens (gold, France)	42	Russian Scale Mikhail Fedorovich, 1613-1645, Silver, 0.625 gr.	65
Polish Zloty (Pre-WWII) 0.20 zl (1923 nickel)	44-99	Bulgarian 5 stotinkas (old) (CuAlNi)	68-73
Celtic Potin (copper+lead)	52	Bulgarian 1 lev	69-73
Polish Zloty 0.50PLN	54-56	10 Euro Cent	70-74
USSR 50 kopeek, 1980, Nickel, D 24 mm.	56	1 Euro Coin	70-78
Russian Scale Peter I, 1705, Silver, 0.25 gr.	56-57	Medieval double sol coin (France)	75
Polish Zloty 1PLN	56-57	20 Euro Cent	76-78
US Nickel	56-57	50 Euro Cent	76-80
Polish Zloty PRL 100zl (CuNi)	58-59	Double Tournois (copper, France)	78
Bulgarian 1 stotinkas, 1999 (CuAlNi)	58-64	British £1	79-80
Bulgarian 10 stotinkas, 1999	59-60	Polish Zloty PRL 20 zl (aluminum)	80
Bulgarian 50 stotinkas, 1999,2004,2005,2007	59-65	10 ct Napoleon III (bronze, France)	80
Roman Nummus (bronze)	60	British £2	81
1/4 of Stater (gold, France)	60	2 Franc Morlon (Aluminum, France)	82
50cent Chambre du Commerce (France)	60	US Dime	84-85
Bulgarian 2 stotinkas, 1999 (CuAlNi)	60-64	Polish Zloty (Pre-WWII) 2zl (1933 silver)	86-87
Polish Zloty 5PLN	61	US Quarter	88-90
2 Euro Coin	62-66	Russian, 50 kopeek Nikolay II, 1896, Silver, D 27 mm.	93-94
Polish Zloty '0.05PLN	63-64	US Silver Dollar	94-95
British 20p	64-65	Russian, 2 kopeek, Alexander I, 1816, Copper, D 30 mm.	94-95
Polish Zloty 2PLN	64-65	Russian, 1 ruble Nikolay II, 1896, Silver, D 34 mm.	98
USSR, 5 kopeek, 1961, Bronze, D 25 mm.	65	Russian, 5 kopeek, Ekaterina II, 1781, Copper, D 41 mm.	99

MODE SELECTIONS

IRON IDENTIFICATION

Variable Iron Identification & Discrimination

The Eurotek Pro allows the user not only to discriminate iron targets, but classifies them by size and signal strength. Ferrous objects will have a Target-ID between 1 and 39.

To eliminate all ferrous objects from detection, set DISC = 39.

Alternatively, the user can selectively eliminate ferrous objects less than a given Target-ID. For example, to eliminate ferrous objects with an ID of less than 15, choose a DISC setting of 14.

FeTone™, Adjustable Iron Audio

Volume settings 10-20 allow the user to change the volume response of ferrous metals, as described on page 13.

Iron-Indicator

The IRON icon flashes momentarily when ferrous objects are present. The IRON icon flashes independent of the discrimination setting. The user cannot disable this icon.

Relic hunters will frequently seek out iron-laden sites as good prospective treasure-hunting sites. The Eurotek Pro Iron-Indicator is intended for this purpose. The indicator alerts the user to the presence of iron, even if iron has been discriminated out. Relic hunters can search free of iron-target audio, yet still be alerted to the presence of ferrous objects or search with no discrimination and use the FeTone™ feature to decrease the Audio Volume of ferrous targets.

PINPOINT MODE

Press-and-hold  to enter the no-motion Pinpoint Mode of operation. "PP" is momentarily displayed on the screen.

In Pinpoint Mode:

- No searchcoil motion is required.
Any metal object in the searchcoil's field of detection will induce an audible hum, regardless of whether the searchcoil is in motion or motionless.
- Target-ID is not possible.
- Discrimination is not possible.
All metal targets are detected, regardless of the DISC setting.
- Audio feedback is V.C.O.
All targets induce V.C.O. audio, regardless of the DISC setting.
- Target depth is displayed.

Pinpoint is typically used to precisely identify the location of an object previously detected in the Discrimination Mode.

The Pinpoint Mode can also be useful in tracing the outline of larger objects. Since searchcoil motion is not required, very slow movement around an object can reveal an outline of its shape.

While not intended as a continuous-search mode, Pinpoint can be used in this fashion if the user keeps the button depressed.

MODE SELECTIONS

Pinpoint Mode *(continued)*

If used for continuous-search, be aware that the signal is subject to drift with both time and temperature change. Drift will cause either an increase or decrease in sensitivity. In the most extreme case, the signal will drift upward until the detector sounds off continuously with no target present.

Pinpoint Depth Indicator

While  is depressed, a 2-digit number indicates the depth of the target. This depth indicator is calibrated to a coin-sized object. The maximum depth reading, 25CM or 09IN, may display in the event of electrical noise or a very weak signal.

To demonstrate the depth indicator function, hold a coin over the searchcoil, press-and-hold  and then move a coin toward and away from the searchcoil. Hold the coin flat, parallel to the searchcoil. Watch the depth indicator change as the distance from the searchcoil changes.

Pinpoint Retuning

Retuning in the Pinpoint Mode is useful in narrowing down the location of a target.

To retune the detector, quickly release the button and immediately depress the button again.

When the user releases , “t” is displayed momentarily on the screen. The “t” indicates that the detector is retuning to the incoming signal level.

How to Pinpoint

Position the searchcoil 2 to 5 cm (1”-2”) above the ground, and to the side of the target. Then press and hold . Now move the searchcoil slowly across the target, and the sound will communicate the target’s location. As you sweep from side to side, and hear no sound at the ends of the sweep, the target is located in the middle of that zone, where the sound is loudest. If the sound is loud over a wide area, the buried object is large. Use Pinpoint to trace an outline of such large objects.

Narrow It Down

To further narrow the field of detection, position the searchcoil near the center of the response pattern (but not at the exact center), release , and then quickly press-and-hold it again. Now you will only hear a response when the searchcoil is right over the top of the target. Repeat this procedure to narrow the zone even further. Each time you repeat the procedure, the field of detection will narrow further.

Consider Purchasing a Pinpointer

When you kneel down to unearth an object, you may find it frustrating as the object can appear exactly like the surrounding soil. You may hold the object in your hand, and find it necessary to pass a handful of dirt over the searchcoil to see if it contains metal. An easier way is to use a handheld pinpointer. It is a probe-like device which is poked into the ground, making close up pinpointing a snap, reducing digging time, and minimizing the size of the holes you will dig. Teknetics offers a robust and inexpensive pinpointer designed for this purpose.

OTHER FEATURES

Overload Warning

If a metal object or highly magnetic soil are too close to the searchcoil, the detector will “overload.”

“— —” will appear on the screen and the detector will make a rapid, repeating mid-tone warning sound.

Overload will not harm the detector, but the detector will not function under these conditions.





Raise the searchcoil to search at a greater distance, or move to a different location.

Unit of Measure (U/M)

The depth indicator in Pinpoint Mode can display either centimeters (CM) or inches (IN).

The default unit of measure is centimeters (CM).

To change the unit of measure:



1. Start with the detector turned OFF.
2. Press-and-hold .
3. Press .
Continue to hold down .
4. Quickly release and then immediately press-and-hold  again to toggle between CM and IN.
5. When the desired U/M appears on the screen, release .

The detector will now operate with the desired U/M, even after the detector has been powered down.

To change the U/M again, repeat the procedure.

Memory



To store the current settings (SENS, DISC and VOL):

1. Start with the detector turned ON.
2. Select all desired settings.
3. Press-and-hold  for 8 seconds.
4. When the three menu selections appear at the bottom of the screen, release .

When you turn the detector ON for future use, your detector will resume operation with your programmed settings.

Reset

To return all detector settings to the factory defaults:

1. Start with the detector turned OFF.
2. Press-and-hold .
3. Press .
4. Release .

The 2-digit number displayed is the software revision number.

TROUBLESHOOTING

TROUBLESHOOTING GUIDE		
SYMPTOM	CAUSE	SOLUTION
Detector chatters or beeps erratically	<ul style="list-style-type: none"> • Using detector indoors • Using detector near power lines • Using 2 detectors in close proximity • Highly oxidized buried object • Environmental electromagnetic interference 	<ul style="list-style-type: none"> • Use detector outdoors only • Move away from power lines • Keep 2 detectors at least 6 meters (20') apart • Only dig up repeatable signals • Reduce sensitivity until erratic signals cease
Constant low tone or constant repeating tones	<ul style="list-style-type: none"> • Discharged battery • Wrong type of battery 	<ul style="list-style-type: none"> • Replace battery • Use only 9V alkaline battery
LCD does not lock on to one Target-ID or detector emits multiple tones	<ul style="list-style-type: none"> • Multiple targets present • Highly oxidized target • Sensitivity set too high 	<ul style="list-style-type: none"> • Move coil slowly at different angles • Reduce sensitivity
No power, no sounds	<ul style="list-style-type: none"> • Dead battery • Cord not connected securely 	<ul style="list-style-type: none"> • Replace battery • Check connections

Note: This equipment has been tested and found to comply with the limits for a Class B digital device, pursuant to part 15 of the FCC Rules. These limits are designed to provide reasonable protection against harmful interference in a residential installation. This equipment generates uses and can radiate radio frequency energy and, if not installed and used in accordance with the instructions, may cause harmful interference to radio communications. However, there is no guarantee that interference will not occur in a particular installation. If this equipment does cause harmful interference to radio or television reception, which can be determined by turning the equipment off and on, the user is encouraged to try to correct the interference by one or more of the following measures:

- Reorient or relocate the receiving antenna.
- Increase the separation between the equipment and receiver.
- Consult the dealer or an experienced radio/TV technician for help.

CE The manufacturer declares that the minimum ESD performance criteria is 1) the unit shall not be permanently damaged and 2) operator intervention is allowed.

This product meets the requirements of Industry Canada: CAN ICES-3 B/NMB-3 B.

ACCESSORIES

Teknetics® Padded Carrying Bag.

Made of rugged double-stitched nylon construction. Includes handy outside zip-pocket for extra batteries or small accessories. – *CBAG-T*

Teknetics® Camo Pouch

Camo pouch with two inside pockets, belt included. - *PCH-T*

Teknetics® Stereo Headphones

Use with Teknetics® metal detectors with true stereo. Utilizes 1/4-inch stereo & 1/8-inch plug. Compatible with all Teknetics® models with 1/4-inch & 1/8-inch jacks. – *HEADT*

Arm Strap

Secure your detector to your arm for a perfect swing – *2021112000*

Teknetics® Pinpointer

Pinpoints the exact location of buried metal objects. Audio signal indicator and vibrator. No assembly required, runs on (1) 9-Volt Battery. – *PINPOINTER*

Digging Trowel

One-piece stainless steel construction with depth gauge - *TROWEL-2*

Gold Pick

Tempered steel head is 10" long and the edge is 3 1/4" wide. The overall length is 19" with a durable fiberglass handle and a rubberized hand grip. Includes a powerful magnet attached to the head to quickly discriminate iron targets and magnetic hot rocks. – *GOLDPICK*

Lesche Knife

Made from high quality heat-treated tempered steel. The ultimate digging tool. Comes with a durable sheath.

12" in length with a 7" serrated blade - *LESCH KNIFE*

Eurotek® T-Shirt

100% cotton with Eurotek® Logo. Sizes S, M, LG, XL & XXL – *ETPTSHIRT*

Eurotek® Baseball Cap

One size fits all - *ETPCAP*

Rain Cover

Custom made to protect from weather - *RAINCOV-ET*

Extended Lower Stem

For taller users - *TUBE5X* (image not shown)

Replacement & Accessory Searchcoils and Protective Covers

Searchcoil Item#

Description

Protective Cover Item#

5COIL-TEK	Searchcoil, 5"DD Round, closed
8COIL-7TEK *	Searchcoil, 8" Concentric, open
10COIL-TEK	Searchcoil, 10" Concentric, open
10COILDD-TEK	Searchcoil, 10"DD Ellipse, closed
11COIL-TEK **	Searchcoil, 11"DD Ellipse, open

5COVER-CZ3
8COVER-7
F70COVER
2023190000
COVER-11DD

* standard with detector

** standard with ETEKPRO11DD-SKD

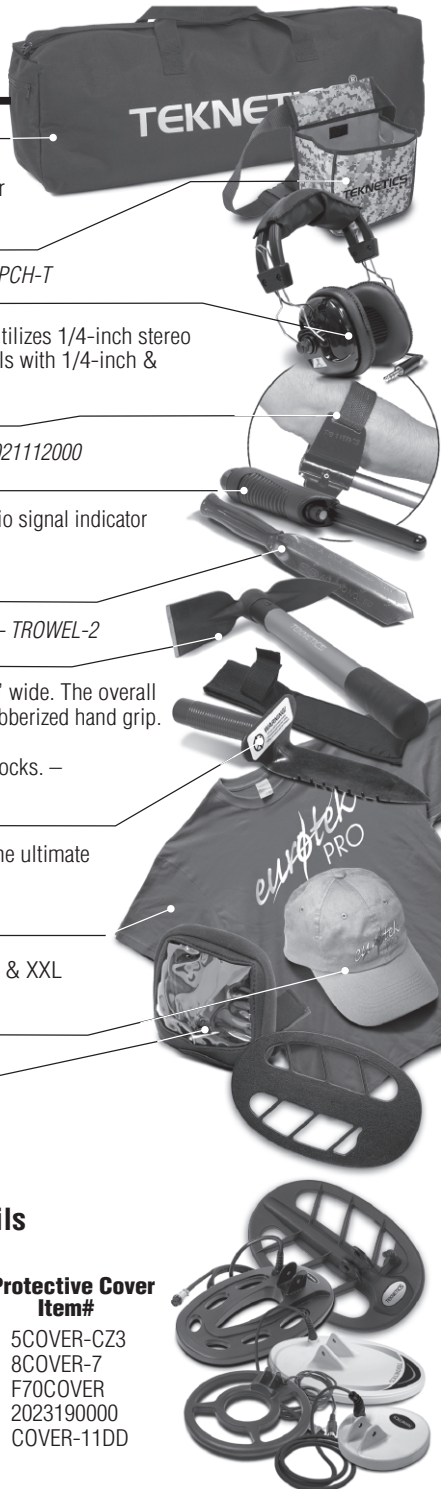

TREASURE HUNTER'S CODE OF ETHICS:

- Always check Federal, State, County and local laws before searching.
- Respect private property and do not enter private property without the owner's permission.
- Take care to refill all holes and leave no damage.
- Remove and dispose of any and all trash and litter found.
- Appreciate and protect our inheritance of natural resources, wildlife and private property.
- Act as an ambassador for all treasure hunters; use thoughtfulness, consideration and courtesy at all times.
- Never destroy historical or archaeological treasures.
- All treasure hunters may be judged by the example you set; always conduct yourself with courtesy and consideration of others.

5-YEAR LIMITED WARRANTY

The **Eurotek® Pro** metal detector is warranted against defects in materials and workmanship under normal use for five years from the date of purchase to the original owner.

Damage due to neglect, accidental damage or misuse of this product is not covered under this warranty. Decisions regarding abuse or misuse of the detector are made solely at the discretion of the manufacturer.

Proof of Purchase is required to make a claim under this warranty.

Liability under this Warranty is limited to replacing or repairing, at our option, the metal detector returned, shipping cost prepaid, to First Texas Products. Shipping cost to First Texas Products is the responsibility of the consumer.

To return your detector for service, please first contact First Texas Products for a Return Authorization (RA) Number. Reference the RA number on your package and return the detector within 15 days of calling to:

First Texas Products L.L.C.

1120 Alza Drive.
El Paso, TX 79936
Phone: 915-633-8354

NOTICE TO CUSTOMERS OUTSIDE THE U.S.A.

This warranty may vary in other countries; check with your distributor for details.
Warranty does not cover shipping costs to and from the U.S.A.

According to FCC part 15.21, changes or modifications made to this device not expressly approved by the party responsible for compliance could void the user's authority to operate this equipment.
This device complies with FCC Part 15 Subpart B Section 15.109 Class B.

Copyright© 2019 by First Texas Products, L.L.C.

All rights reserved, including the right to reproduce this book, or parts thereof, in any form, except for the inclusion of brief quotations in a review.

Published by First Texas Products, L.L.C.

Operational Weight: 1.077 kg (2 lbs. 6oz.), with 11DD coil: 1.19 kg (2 lbs. 10oz.)

TEKNETICS®

1120 Alza Drive • El Paso, TX 79907 • (915) 633-8354

www.tekneticsdirect.com